

## Datasheet - ZK 256 STR-AS



AS interface safety at work / Safety switchgear / Safety switches / 256 AS / AS - 256 Offset roller lever K



- AS-Interface M12 connector
- Thermoplastic enclosure
- Wide range of alternative actuators
- Good resistance to oil and petroleum spirit
- 73,5 mm x 50,5 mm x 31 mm
- Actuator heads can be repositioned by 4 x 90°
- Mounting details to EN 50047
- AS-Interface LED and status display
- Integrated AS-Interface
- Suitable for AS-i Power24

(Minor differences between the printed image and the original product may exist!)

### Ordering details

Product type description	ZK 256 STR-AS
Article number	ZK 256 STR-AS
EAN Code	
eCl@ss	27-27-26-01

### Approval

Approval



### Classification

Standards	EN ISO 13849-1, IEC 61508
PL	up c
Control category	up 1
PFH	1.14 x 10 <sup>-6</sup> /
- notice	up to max. 100000 switching cycles/year
SIL	up 1
Mission time	20 Years

If a fault exclusion for hazardous damage of the 1-channel mechanics is authorized and an adequate protection against tampering is ensured, suitable for use up to:

Standards	EN ISO 13849-1, IEC 61508
-----------	---------------------------

PL	up d
Control category	up 3
PFH value	1.01 x 10 <sup>-7</sup> /
- notice	up to max. 100000 switching cycles/year
SIL	up 2
Mission time	20 Years

## Global Properties

---

Permanent light	AS - 256 Rollenhebel K
Standards	EN 50295, EN 60947-5-1, EN ISO 13849-1, IEC 61508
Compliance with the Directives (Y/N) 	Yes
Suitable for safety functions (Y/N)	Yes
Actuator type	E to EN 50047
Materials	
- Material of the housings	Plastic, glass-fibre reinforced thermoplastic, self-extinguishing
- Material of the connector	Plastic
- Material of the contacts	Silver
Housing coating	
Housing construction form	Norm construction design
Weight	

## Mechanical data

---

Design of electrical connection	connector plug M12, 4-pole
connector	right
Mechanical life	1.000.000 operations
Switching frequency	5000
Design of actuating element	Offset roller lever
Actuating force	9
restistance to shock	30 / 11
Resistance to vibration	10 ... 150, Amplitude 0,35 / 5
Positive break force	19
Actuating speed for vertical actuation	
- Max. Actuating speed	1

## Ambient conditions

---

Ambient temperature	
- Min. environmental temperature	-25
- Max. environmental temperature	+60
- Min. Storage and transport temperature	-25
- Max. Storage and transport temperature	+85
Relative humidity	30 ... 95
- non-condensing	
- non-icing	
Protection class	IP67 to IEC/EN 60529
Protection rating	II

## Electrical data

---

Design of control element	Opener (NC)
Switching principle	Snap switch element

- positive break NC contact 	
Number of auxiliary contacts	0
Number of safety contacts	2
Rated impulse withstand voltage	800
Rated insulation voltage	32
Thermal test current	10 A
Utilisation category	AC-15: 230 V / 4 A, DC-13: 24 V / 1 A
Max. fuse rating	6 A gG D-fuse

## Electrical data - AS interface

---

AS-i Supply voltage	18 ... 31.6 VDC, Protection against polarity reversal
AS-i operating current	≤ 50
AS-i Device insulation	internally short-circuit proof
AS-i Specification	
- version	V 3.0
- Profile	S-0.B.F.F
AS-i Inputs	
- Channel 1	Data bits DI 0/DI 1= dynamic code transmission
- Channel 2	Data bits DI 2/DI 3= dynamic code transmission
AS-i Outputs	DO 0 ... DO 3 not used
AS-i Parameter bits	P1 ... P3 not used
- P0	Channel 2 switched
AS-i input module address	0
- Default on address 0, programmable via the AS-Interface Master or Hand-held programming device	

## LED switching conditions display

---

LED switching conditions display (Y/N)	Yes
AS-i LED switching conditions display	
(1) yellow LED	Channel 1 / AS-i SaW Bit 0,1
(2) green/red LED (AS-i duo LED)	Supply voltage / Communication error / slave address = 0
(3) yellow LED	Channel 2 / AS-i SaW Bit 2,3

## ATEX

---

Explosion protection categories for gases	None
Explosion protected category for dusts	None

## Dimensions

---

Dimensions of the sensor	
- Width of sensor	73.5
- Height of sensor	108.6
- Length of sensor	30

## Pin assignment



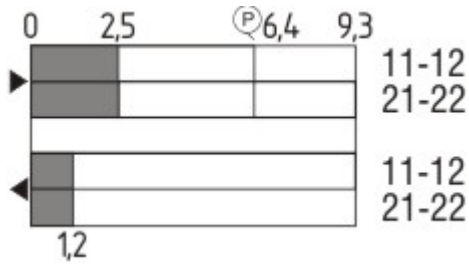

---

1	AS interface +
2	None
3	AS interface -
4	None
5	Functional earth connection

## Switch travel diagram



### Notes Switch travel diagram

-  Contact closed
-  Contact open
-  Setting range
-  Break point
-  Positive opening sequence/- angle
- VS** adjustable range of NO contact
- VÖ** adjustable range of NC contact
- N** after travel

## Ordering suffix

The applicable ordering suffix is added at the end of the part number of the safety switch.

Order example: ZK 256 STR-AS-**STL**

.... <b>STL</b>	connector plug M12, left
.... <b>FKR</b>	Connection for flat cable, right
.... <b>FKL</b>	Connection for flat cable, left

## Ordering code

(1)(2) 256 (3)-AS

(1)

<b>Z</b>	Snap action
<b>T</b>	Slow action

(2)

<b>S</b>	Plunger S
<b>R</b>	Roller plunger R
<b>1R</b>	Offset roller lever 1R
<b>K</b>	Angle roller lever K
<b>3K</b>	Angle roller lever 3K
<b>4K</b>	Angle roller lever 4K
<b>K4</b>	Angle roller lever K4
<b>1H</b>	Roller lever 1H
<b>12H</b>	Roller lever 12H
<b>14H</b>	Roller lever 14H
<b>7H</b>	Roller lever 7H

(3)

<b>STR</b>	connector plug M12 right
<b>STL</b>	connector plug M12, left
<b>FKR</b>	Connection for flat cable, right
<b>FKL</b>	Flat plug-in connector, left

## Documents

---

**Operating instructions and Declaration of conformity (it)** 309 kB, 09.10.2018

Code: mrl\_zt235-236as\_it

**Operating instructions and Declaration of conformity (pt)** 314 kB, 09.10.2018

Code: mrl\_zt235-236as\_pt

**Operating instructions and Declaration of conformity (de)** 320 kB, 09.10.2018

Code: mrl\_zt235-236as\_de

**Operating instructions and Declaration of conformity (es)** 312 kB, 09.10.2018

Code: mrl\_zt235-236as\_es

**Operating instructions and Declaration of conformity (da)** 301 kB, 09.10.2018

Code: mrl\_zt235-236as\_da

**Operating instructions and Declaration of conformity (nl)** 346 kB, 09.10.2018

Code: mrl\_zt235-236as\_nl

**Operating instructions and Declaration of conformity (en)** 313 kB, 09.10.2018

Code: mrl\_zt235-236as\_en

**Operating instructions and Declaration of conformity (fr)** 314 kB, 09.10.2018

Code: mrl\_zt235-236as\_fr

**Operating instructions and Declaration of conformity (jp)** 422 kB, 09.10.2018

Code: mrl\_zt235-236as\_jp

**Operating instructions and Declaration of conformity (pl)** 327 kB, 09.10.2018

Code: mrl\_zt235-236as\_pl

**TÜV certification (de, en)** 249 kB, 20.01.2017

Code: z\_235p03

## Images

---



Product photo

---



Product photo

---

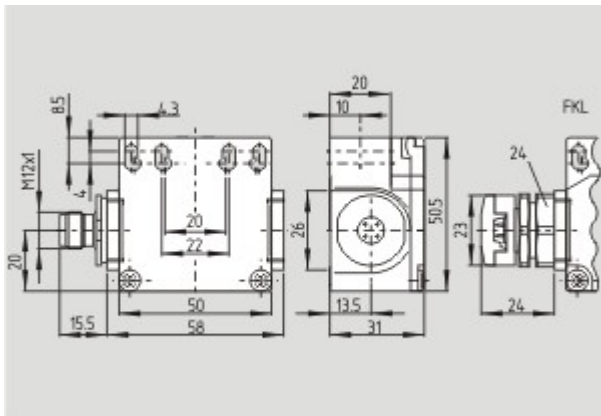

Dimensional drawing (basic component)

---

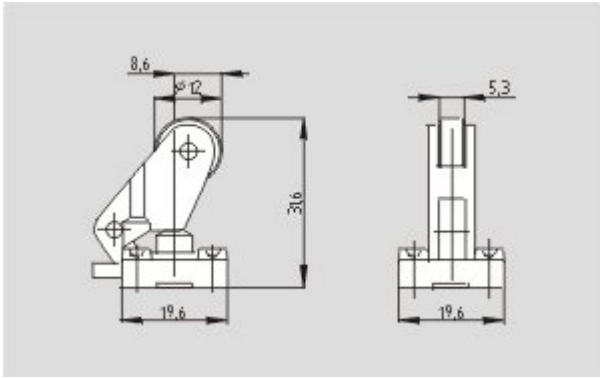

Dimensional drawing (actuator)

---

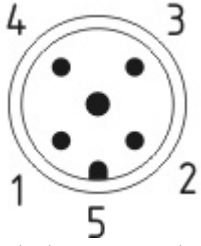

Contact arrangement

---

K.A. Schmersal GmbH & Co. KG, Möddinghofe 30, D-42279 Wuppertal

The data and values have been checked thoroughly. Technical modifications and errors excepted.

Generiert am 13.02.2019 - 12:42:14h Kasbase 3.3.0.F.64I