

Datasheet - PS116-T11-LR200-R200



Position switch / PS116 Thermoplastic enclosure - EN 50047 with Actuator / PS116 Roller plunger R200



- Thermoplastic enclosure
- Symmetric enclosure
- Protection class IP66, IP67
- Pre-wired cable right, 2
- Slow action 1 Normally open contact (NO) / 1 Opener (NC)

(Minor differences between the printed image and the original product may exist!)

Ordering details

Product type description	PS116-T11-LR200-R200
Article number	103006566
EAN Code	
eCl@ss	27-27-26-01

Approval

Approval

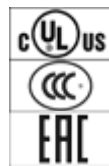

Classification

Standards	ISO 13849-1
B10d Normally-closed contact (NC)	20.000.000
Mission time	20 Years
notice	$MTTF_d = \frac{B_{10d}}{0,1 \times n_{op}}$ $n_{op} = \frac{d_{op} \times h_{op} \times 3600 \text{ s/h}}{t_{cycle}}$

Global Properties

Permanent light	PS116 Rollendruckbolzen R200
Standards	IEC 60947-5-1
Compliance with the Directives (Y/N)	Yes
Suitable for safety functions (Y/N)	Yes

Actuator type	C to EN 50047
Materials	
- Material of the housings	Plastic, glass-fibre reinforced thermoplastic, zinc die-cast, chromated
- Material of the contacts	Silver
Housing coating	None
Housing construction form	Norm construction design
Cable colour	Grey
Cable type	LiYY
Weight	150 g

Mechanical data

Design of electrical connection	Cable, 4-pole
Connector	right
Conductors	4 x 0,5 mm ²
Mechanical life	10.000.000 operations
Switching frequency	max. 5000 /h
Design of actuating element	Roller plunger R200
Actuating force	min. 10 N
Bounce duration	< 3 ms
Switchover time	< 5.5 ms
Positive break force	40 N
Actuating speed for vertical actuation	
- Min. Actuating speed	120 mm/min
- Max. Actuating speed	1 m/s
Cable length	2 m

Ambient conditions

Ambient temperature	
- Min. environmental temperature	-30 °C
- Max. environmental temperature	+80 °C
Protection class	IP66, IP67

Electrical data

Design of control element	Normally open contact (NO), Opener (NC)
Switching principle	Creep circuit element
- positive break NC contact 	
Number of auxiliary contacts	1 piece
Number of safety contacts	1 piece
Rated impulse withstand voltage U _{imp}	4 kV
Rated insulation voltage U _i	300 V
Thermal test current I _{the}	5 A
Utilisation category	AC-15: 240 V / 3 A, DC-13: 24 V / 1,5 A
Required rated short-circuit current	1000 A
Max. fuse rating	6 A gG D-fuse (quick-blow)

ATEX

Explosion protection categories for gases	None
Explosion protected category for dusts	None

Dimensions

Dimensions of the sensor

- Width of sensor	31 mm
- Height of sensor	74.1 mm
- Length of sensor	16.6 mm
Roller diameter	9.5 mm

Diagram

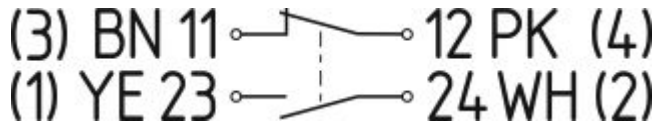

Note Diagram

- positive break NC contact
- active
- no active
- Normally-open contact
- Normally-closed contact

Switch travel diagram

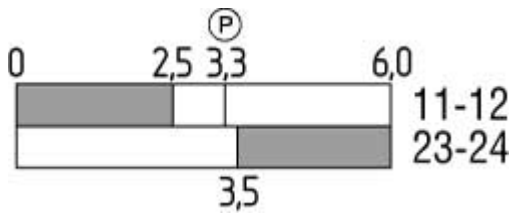

Notes Switch travel diagram

- Contact closed
- Contact open
- Setting range
- Break point
- Positive opening sequence/- angle
- VS** adjustable range of NO contact
- VÖ** adjustable range of NC contact
- N** after travel

Ordering code

PS116-(1)-(2)-(3)-(4)

(1)

Z11	Snap action 1 Normally open contact (NO) / 1 Opener (NC)
Z02	Snap action 2 Opener (NC)
Z12	Snap action 1 Normally open contact (NO) / 2 Opener (NC)
Z11R	Snap action 1 Normally open contact (NO) / 1 Opener (NC) with Latching
Z02R	Snap action 2 Opener (NC) with Latching
Z12R	Snap action 1 Normally open contact (NO) / 2 Opener (NC) with Latching
T11	Slow action 1 Normally open contact (NO) / 1 Opener (NC)
T02	Slow action 2 Opener (NC)
T20	Slow action 2 Normally open contact (NO)
T12	Slow action 1 Normally open contact (NO) / 2 Opener (NC)

T21	Slow action 2 Normally open contact (NO) / 1 Opener (NC)
T03	Slow action 3 Opener (NC)
T11UE	Slow action with overlapping contacts 1 Normally open contact (NO) / 1 Opener (NC)
T02H	Slow action with staggered contacts 2 Opener (NC)
(2)	
L200	Pre-wired cable bottom, Cable length 2 m
LR200	Pre-wired cable right, Cable length 2 m
ST	connector plug M12, bottom
STR	connector plug M12, right
(3)	
S20	Plunger S200
R20	Roller plunger R200
K20	Offset roller lever K200
K21	Offset roller lever K210
K23	Angle roller lever K230
K24	Angle roller lever K240
K25	Angle roller lever K250
H20	Roller lever H200
N20	Roller lever N200
J20	Rod lever J200
(4)	
0	Material Castor/Roller: Plastic
1	Material Castor/Roller: Stainless steel
2	Material Castor/Roller: Brass
3	Material Castor/Roller: Aluminium
4	Material Castor/Roller: Steel

Documents

Operating instructions (en) 628 kB, 06.07.2018

Code: mrlk_ps116_en

Operating instructions (pl) 659 kB, 16.02.2017

Code: mrlk_ps116_pl

Operating instructions (pt) 628 kB, 17.03.2017

Code: mrlk_ps116_pt

Operating instructions (nl) 0 Byte, 28.02.2018

Code: mrlk_ps116_nl

Operating instructions (es) 627 kB, 06.07.2018

Code: mrlk_ps116_es

Operating instructions (de) 630 kB, 06.07.2018

Code: mrlk_ps116_de

Operating instructions (fr) 629 kB, 11.05.2017

Code: mrlk_ps116_fr

Operating instructions (it) 626 kB, 30.06.2017

Code: mrlk_ps116_it

Declaration of conformity (en) 88 kB, 22.11.2017

Code: konfi_mrl_ps116_en

Declaration of conformity (de) 87 kB, 22.11.2017

Code: konfi_mrl_ps116_de

Brochure (jp) 1 MB, 14.10.2015

Code: b_ps116_jp

Brochure (cs) 1 MB, 14.10.2015

Code: b_ps116_cs

Brochure (de) 2 MB, 09.10.2015

Code: b_ps116_de

Brochure (en) 1 MB, 14.10.2015

Code: b_ps116_en

Brochure (nl) 1 MB, 14.10.2015

Code: b_ps116_nl

Brochure (it) 1 MB, 14.10.2015

Code: b_ps116_it

Brochure (pl) 1 MB, 14.10.2015

Code: b_ps116_pl

Brochure (pt) 1 MB, 14.10.2015

Code: b_ps116_pt

Brochure (es) 1 MB, 14.10.2015

Code: b_ps116_es

Brochure (fr) 1 MB, 14.10.2015

Code: b_ps116_fr

CCC certification (en) 1 MB, 22.06.2017

Code: q_ps1p01

CCC certification (cn) 1 MB, 22.06.2017

Code: q_ps1p02

EAC certification (ru) 844 kB, 05.10.2015

Code: q_6037p17_ru

Images



Product photo

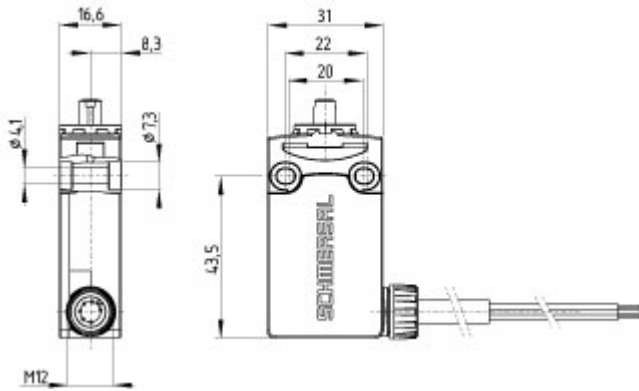

Dimensional drawing (basic component)

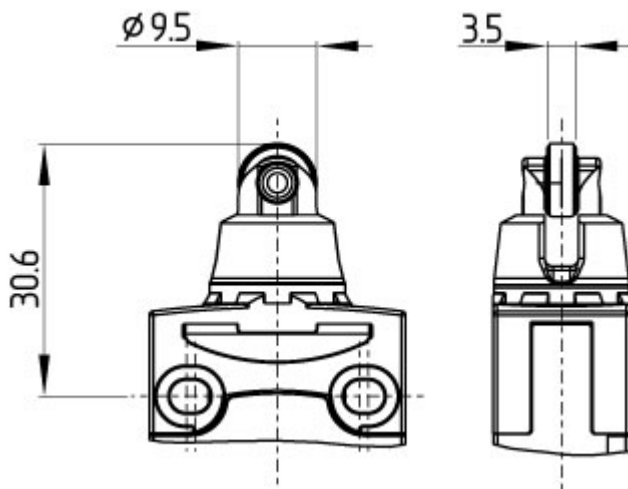

Dimensional drawing (actuator)

K.A. Schmersal GmbH & Co. KG, Möddinghofe 30, D-42279 Wuppertal

The data and values have been checked thoroughly. Technical modifications and errors excepted.

Generiert am 13.02.2019 - 13:50:27h Kasbase 3.3.0.F.64I