

Datasheet - T4V7H 355-11ZUE-2138

Position switch / 355 Metal enclosure - EN 50041 with Actuator / 355 Roller lever 7H-2138



- Metal enclosure
- Wide range of alternative actuators
- Good resistance to oil and petroleum spirit
- 66,7 mm x 76 mm x 38 mm
- 3 cable entries lateral M 20 x 1.5
- Actuator heads can be repositioned by 4 x 90°
- Mounting details to EN 50041
- Switching points to EN 50041

(Minor differences between the printed image and the original product may exist!)

Ordering details

Product type description	T4V7H 355-11ZUE-2138
Article number	101193706
EAN Code	4030661356624
eCl@ss	27-27-26-01

Approval

Approval

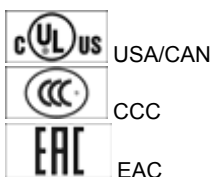

Classification

Standards	EN ISO 13849-1
B10d Normally-closed contact (NC)	20.000.000
Mission time notice	20 Years
	$MTTF_d = \frac{B_{10d}}{0,1 \times n_{op}}$
	$n_{op} = \frac{d_{op} \times h_{op} \times 3600 \text{ s/h}}{t_{cycle}}$

Global Properties

Permanent light	T 355 Rollenschwenkhebel 7H 2138
Standards	EN 60947-5-1, BG-GS-ET-15
Compliance with the Directives (Y/N) 	Yes
Suitable for safety functions (Y/N)	Yes
Materials	
- Material of the housings	Aluminium
- Lever material	Metal film
- Roller material	Plastic
- Material of the contacts	Silver
Housing coating	painted
Housing construction form	Norm construction design
Weight	260

Mechanical data

Design of electrical connection	Screw connection
Cable section	
- Min. Cable section	0,75
- Max. Cable section	2.5
Mechanical life	30.000.000 operations
Switching frequency	max. 5000 /h
notice	All indications about the cable section are including the conductor ferrules.
Design of actuating element	Roller lever
actuating torque	min. 31 Ncm
Bounce duration	< 2
Switchover time	in accordance with actuating speed
Actuating speed with actuating angle 30° to switch axis	
- Min. Actuating speed	
- Max. Actuating speed	2.5 m/s

Ambient conditions

Ambient temperature	
- Min. environmental temperature	-30 °C
- Max. environmental temperature	+80 °C
Protection class	IP67

Electrical data

Design of control element	Normally open contact (NO), Opener (NC)
Switching principle	Slow action with overlapping contacts
- positive break NC contact 	
Number of auxiliary contacts	1
Number of safety contacts	1
Rated impulse withstand voltage U_{imp}	6 kV
Rated insulation voltage U_i	500 V
Thermal test current I_{the}	10 A
Utilisation category	AC-15: 230 V / 4 A, DC-13: 24 V / 4 A
Required rated short-circuit current	1000 A
Max. fuse rating	6 A gG D-fuse

ATEX

Explosion protection categories for gases
Explosion protected category for dusts

None
None

Dimensions





Dimensions of the sensor

- Width of sensor	66.7 mm
- Height of sensor	173.5 mm
- Length of sensor	57.25 mm

Diagram





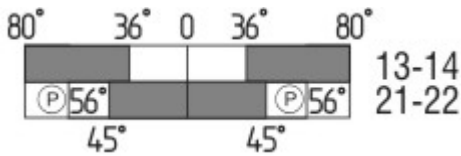

Note Diagram

-  positive break NC contact
-  active
-  no active
-  Normally-open contact
-  Normally-closed contact

Switch travel diagram



Notes Switch travel diagram

-  Contact closed
-  Contact open
-  Setting range
-  Break point
-  Positive opening sequence/- angle
- VS** adjustable range of NO contact
- VÖ** adjustable range of NC contact
- N** after travel

Ordering suffix

The applicable ordering suffix is added at the end of the part number of the safety switch.

Order example: T4V7H 355-11ZUE-2138-**1637**

....-**1637**

0,3 µm gold-plated contacts

....-**NPT**

Cable entry NPT 1/2"

M12 connector with A-coding
Rated impulse withstand voltage U_{imp} : 0,8 kV
Rated insulation voltage U_i : 50 V
Operating current I_e : AC-15: 50 V / 4 A

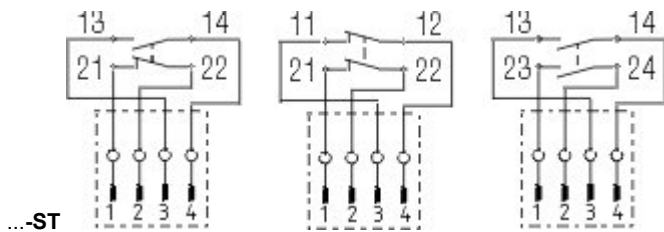

...-ST

Caution! The versions with connector may only be used in PELV circuits to EN 60204-1.

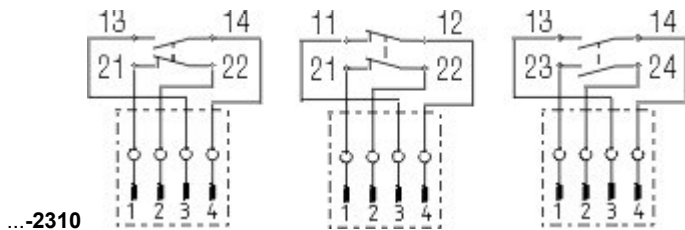

...-2310

M12 connector with B-coding

Rated impulse withstand voltage U_{imp} : 0,8 kV

Rated insulation voltage U_i : 50 V

Operating current I_e : AC-15: 50 V / 4 A

Caution! The versions with connector may only be used in PELV circuits to EN 60204-1.

Ordering code

(1)(2) 3(3)5-(4)Z(5)-(6)-(7)-(8)-(9)

(1)

Z

T

(2)

S

R

H

10H

7H

1K

3K

(3)

3

5

(4)

11

02

20

01/01

12

03

(5)

H

UE

(6)

G24

(7)

without

NPT

ST

ST-2310

Snap action

Slow action

Plunger S

Roller plunger R

Roller lever H

Rod lever 10H

Roller lever 7H

Offset roller lever 1K

Angle roller lever 3K

slim design

large design

1 Normally open contact (NO) / 1 Opener (NC)

2 Opener (NC)

2 Normally open contact (NO) (*Switch with 2 NO contacts are not for security tasks*)

1 Opener (NC) left / 1 Opener (NC) right

1 Normally open contact (NO) / 2 Opener (NC)

3 Opener (NC)

Slow action with staggered contacts

Slow action with overlapping contacts

with LED

Cable entry M20

cable entry NPT 1/2"

M12 connector with A-coding (*Caution! The versions with connector may only be used in PELV circuits to EN 60204-1.*)

M12 connector with B-coding (*Caution! The versions with connector may only be used in PELV circuits to EN 60204-1.*)

(8)

2138 Roller lever 7H for Position switches with safety function

(9)

1637 gold-plated contacts

Documents

Operating instructions and Declaration of conformity (de) 157 kB, 18.06.2018

Code: mrlk_zt332-335-336-355_de

Operating instructions and Declaration of conformity (nl) 162 kB, 27.06.2018

Code: mrlk_zt332-335-336-355_nl

Operating instructions and Declaration of conformity (it) 162 kB, 27.06.2018

Code: mrlk_zt332-335-336-355_it

Operating instructions and Declaration of conformity (pt) 163 kB, 27.06.2018

Code: mrlk_zt332-335-336-355_pt

Operating instructions and Declaration of conformity (pl) 198 kB, 27.06.2018

Code: mrlk_zt332-335-336-355_pl

Operating instructions and Declaration of conformity (en) 160 kB, 18.06.2018

Code: mrlk_zt332-335-336-355_en

Operating instructions and Declaration of conformity (fr) 164 kB, 27.06.2018

Code: mrlk_zt332-335-336-355_fr

Declaration of conformity (es) 91 kB, 18.06.2018

Code: KAS_konfi_nsr_zt2xx-3xx_es

Declaration of conformity (pl) 130 kB, 18.06.2018

Code: KAS_konfi_nsr_zt2xx-3xx_pl

Declaration of conformity (it) 89 kB, 18.06.2018

Code: KAS_konfi_nsr_zt2xx-3xx_it

Declaration of conformity (pt) 90 kB, 18.06.2018

Code: KAS_konfi_nsr_zt2xx-3xx_pt

Declaration of conformity (fr) 89 kB, 18.06.2018

Code: KAS_konfi_nsr_zt2xx-3xx_fr

Declaration of conformity (de) 581 kB, 07.06.2018

Code: KAS_konfi_nsr_zt2xx-3xx_de

Declaration of conformity (en) 579 kB, 07.06.2018

Code: KAS_konfi_nsr_zt2xx-3xx_en

Declaration of conformity (nl) 89 kB, 18.06.2018

Code: KAS_konfi_nsr_zt2xx-3xx_nl

CCC certification (en) 187 kB, 03.08.2015

Code: q_347p02

CCC certification (cn) 166 kB, 03.08.2015

Code: q_347p03

EAC certification (ru) 844 kB, 05.10.2015

Code: q_6037p17_ru

Images

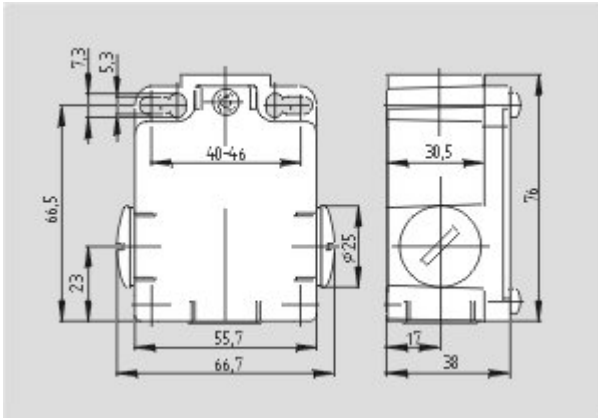

Dimensional drawing (basic component)

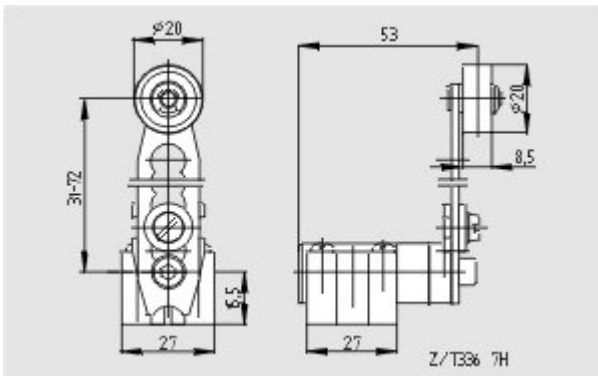

Dimensional drawing (actuator)

K.A. Schmersal GmbH & Co. KG, Möddinghofe 30, D-42279 Wuppertal

The data and values have been checked thoroughly. Technical modifications and errors excepted.

Generiert am 13.02.2019 - 13:28:32h Kasbase 3.3.0.F.64I