

Datasheet - AZ 17-02ZI-B6R

Safety switch with separate actuator / AZ 17ZI / AZ 17/170ZI-B6R



(Minor differences between the printed image and the original product may exist!)

- right-hand model
- For very small actuating radii in line with or at 90° to the plane of the actuator
- Thermoplastic enclosure
- Double-insulated 
- Long life
- 30 mm x 60 mm x 30 mm
- Small body
- Individual coding
- Coding level "High" according to ISO 14119
- High level of contact reliability with low voltages and currents
- Insensitive to soiling
- 8 actuating planes
- Slot sealing plug included
- cable gland M16

Ordering details

Product type description	AZ 17-02ZI-B6R
Article number	101122856
EAN Code	4030661049755
eCI@ss	27-27-26-02

Approval

Approval



Classification

Standards	EN ISO 13849-1
B10d Normally-closed contact (NC)	2.000.000
Mission time	20 Years
notice	$MTTF_d = \frac{B_{10d}}{0,1 \times n_{op}}$ $n_{op} = \frac{d_{op} \times h_{cp} \times 3600 \text{ s/h}}{t_{cycle}}$

Global Properties

Permanent light	AZ 17ZI
Standards	EN 60947-5-1, BG-GS-ET-15
Materials	
- Material of the housings	Plastic, glass-fibre reinforced thermoplastic, self-extinguishing
- Material of the actuator	Stainless steel
- Material of the contacts	Silver
Housing coating	None
Weight	105

Mechanical data

Design of electrical connection	IDC method of termination
Cable section	
- Min. Cable section	1 x 0,75
- Max. Cable section	1 x 1.0, flexible
Mechanical life	> 1.000.000 operations
higher Latching force (Y/N)	No
Latching force	5
Positive break force	17 N
positive break travel	11 mm
Max. Actuating speed	2 m/s

Ambient conditions

Ambient temperature	
- Min. environmental temperature	-30 °C
- Max. environmental temperature	+80 °C
Protection class	IP67 to IEC/EN 60529

Electrical data

Design of control element	Opener (NC)
Switching principle	Creep circuit element
Number of auxiliary contacts	0
Number of safety contacts	2
Supply voltage	
- Min. supply voltage	
- Max. supply voltage	230 V
Rated impulse withstand voltage U_{imp}	4 kV
Rated insulation voltage U_i	250 V
Thermal test current I_{the}	10 A
Utilisation category	AC-15: 230 V / 4 A DC-13: 24 V / 4 A
Max. fuse rating	6 A gG D-fuse

ATEX

Explosion protection categories for gases	None
Explosion protected category for dusts	None

Dimensions

Dimensions of the sensor	
- Width of sensor	30

- Height of sensor	85
- Length of sensor	30

notice

Actuating radius adjustable, minimum 50 mm, using an hexagonal key wrench 2 mm A/F (and a) b

The axis of the hinge should be 11 mm above the top edge of the safety switch and in the same plane

The actuator is not available separately.

This type termination (IDC) method enables simple connection of flexible conductors without the need for the use of conductor ferrules

Included in delivery

Not available as spare part

Included in delivery

- Individually coded actuator
- tamperproof screws
- Slot sealing plugs

Diagram

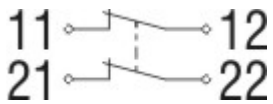

Note Diagram

- positive break NC contact
- active
- no active
- Normally-open contact
- Normally-closed contact

Switch travel diagram



Notes Switch travel diagram

- Contact closed
- Contact open
- Setting range
- Break point
- Positive opening sequence/- angle
- VS** adjustable range of NO contact
- VÖ** adjustable range of NC contact
- N** after travel

Ordering suffix

The applicable ordering suffix is added at the end of the part number of the safety switch.

Order example: AZ 17-02ZI-B6R-**2243**

...-2243 -1	Cable output: rear
...-1637	0,3 µm gold-plated contacts
...-6M	Cable length 6 Meter
...-5M	Cable length 5 Meter

Ordering code

AZ 17-(1)Z(2)I-(3)-(4)-(5)

(1)	
11	1 Normally open contact (NO) / 1 Opener (NC)
02	2 Opener (NC)
(2)	
<i>without</i>	Latching force 5 N
R	Latching force 30 N
(3)	
<i>without</i>	cable gland M16
ST	Connector M12
(4)	
B1	Actuator B1
B5	Actuator B5
B6L	Actuator B6L
B6R	Actuator B6R
(5)	
1637	gold-plated contacts

Documents

Operating instructions and Declaration of conformity (pl) 587 kB, 08.07.2016

Code: mrl_az17i_pl

Operating instructions and Declaration of conformity (es) 556 kB, 27.04.2016

Code: mrl_az17i_es

Operating instructions and Declaration of conformity (en) 551 kB, 22.04.2016

Code: mrl_az17i_en

Operating instructions and Declaration of conformity (fr) 554 kB, 29.04.2016

Code: mrl_az17i_fr

Operating instructions and Declaration of conformity (it) 550 kB, 22.04.2016

Code: mrl_az17i_it

Operating instructions and Declaration of conformity (de) 556 kB, 22.04.2016

Code: mrl_az17i_de

Operating instructions and Declaration of conformity (pt) 555 kB, 13.05.2016

Code: mrl_az17i_pt

Operating instructions and Declaration of conformity (jp) 721 kB, 02.05.2016

Code: mrl_az17i_jp

Operating instructions and Declaration of conformity (cn) 675 kB, 21.06.2017

Code: mrl_az17i_cn

Operating instructions and Declaration of conformity (nl) 585 kB, 29.06.2018

Code: mrl_az17i_nl

Operating instructions and Declaration of conformity (br) 606 kB, 17.05.2016

Code: mrl_az17i_br

Operating instructions and Declaration of conformity (de) 121 kB, 24.09.2018

Code: mrl_az17-azm170-betaetiger_de

Operating instructions and Declaration of conformity (pl) 160 kB, 24.09.2018

Code: mrl_az17-azm170-betaetiger_pl

Operating instructions and Declaration of conformity (it) 120 kB, 24.09.2018

Code: mrl_az17-azm170-betaetiger_it

Operating instructions and Declaration of conformity (da) 134 kB, 24.09.2018

Code: mrl_az17-azm170-betaetiger_da

Operating instructions and Declaration of conformity (pt) 120 kB, 24.09.2018

Code: mrl_az17-azm170-betaetiger_pt

Operating instructions and Declaration of conformity (en) 120 kB, 24.09.2018

Code: mrl_az17-azm170-betaetiger_en

Operating instructions and Declaration of conformity (cs) 157 kB, 24.09.2018

Code: mrl_az17-azm170-betaetiger_cs

Operating instructions and Declaration of conformity (jp) 215 kB, 24.09.2018

Code: mrl_az17-azm170-betaetiger_jp

Operating instructions and Declaration of conformity (sv) 121 kB, 24.09.2018

Code: mrl_az17-azm170-betaetiger_sv

Operating instructions and Declaration of conformity (nl) 120 kB, 24.09.2018

Code: mrl_az17-azm170-betaetiger_nl

Operating instructions and Declaration of conformity (fr) 121 kB, 24.09.2018

Code: mrl_az17-azm170-betaetiger_fr

Operating instructions and Declaration of conformity (es) 120 kB, 24.09.2018

Code: mrl_az17-azm170-betaetiger_es

BG-test certificate (en) 159 kB, 26.11.2015

Code: z_z17p02

BG-test certificate (de) 181 kB, 26.11.2015

Code: z_z17p01

CCC certification (cn) 3 MB, 18.10.2017

Code: q_175p03

CCC certification (en) 3 MB, 29.08.2017

Code: q_175p02

Images

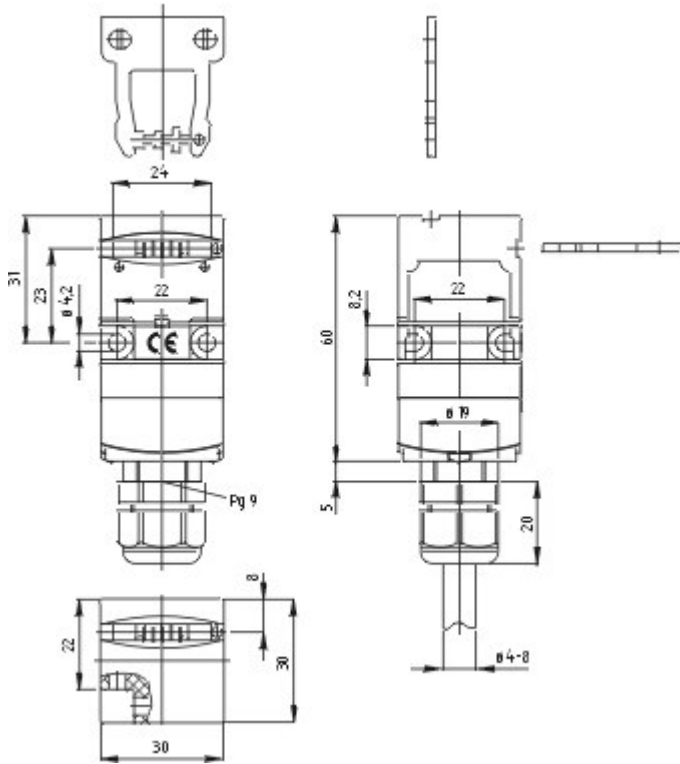

Dimensional drawing (basic component)

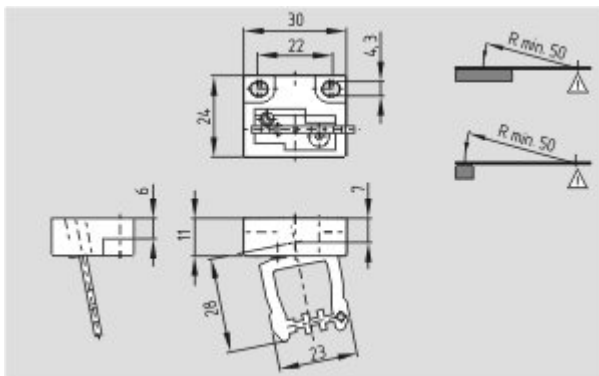

Dimensional drawing (actuator)

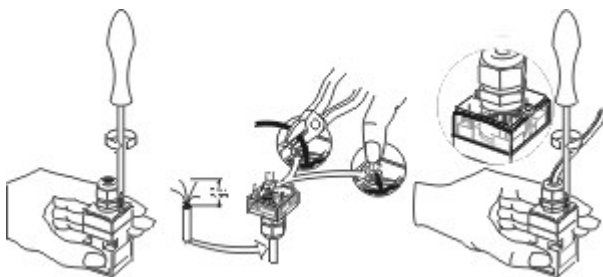

Assembly example

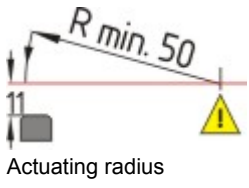
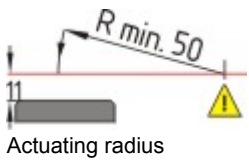

K.A. Schmersal GmbH & Co. KG, Möddinghofe 30, D-42279 Wuppertal

The data and values have been checked thoroughly. Technical modifications and errors excepted.

Generiert am 13.02.2019 - 14:37:53h Kasbase 3.3.0.F.64I