

Datasheet - TV3H 017-13Y



Position switch / medium heavy Position switch / Product series 015, 016, 017 - Metal enclosure / 017 / 017 Roller lever 3H



(Minor differences between the printed image and the original product may exist!)

- Metal enclosure
- 4 Contacts
- 67 mm x 130 mm x 43 mm (basic component)
- Actuator head can be repositioned in steps 4 x 90°
- Continuous adjustment of lever position 360°
- Lever can be transposed by 180°
- 3 Cable entry M 20 x 1.5

Ordering details

| | |
|--------------------------|--------------|
| Product type description | TV3H 017-13Y |
| Article number | 101060404 |
| EAN Code | |
| eCl@ss | 27-27-06-01 |

Approval

Approval



Global Properties

| | |
|--------------------------------------|----------------------------------|
| Permanent light | 017 Rollenschwenkhebel 3H |
| Standards | EN 60947-5-1 |
| Compliance with the Directives (Y/N) | Yes |
| Suitable for safety functions (Y/N) | No |
| Standard housing (Y/N) | No |
| Materials | |
| - Material of the housings | light alloy die-casting, painted |
| - Roller material | Plastic |
| - Material of the contacts | Silver |
| Housing coating | painted |

| | |
|------------|--------|
| Weight | 550 |
| Slide form | Castor |

Mechanical data

| | |
|--|---|
| Design of electrical connection | Screw connection |
| Cable section | |
| - Min. Cable section | 1.5 |
| - Max. Cable section | 2.5 |
| AWG-Number | 13 |
| Active principle | mechanical |
| Mechanical life | 5.000.000 operations |
| notice | All indications about the cable section are including the conductor ferrules. |
| Design of actuating element | Roller lever |
| actuating torque | 24 |
| Bounce duration | |
| Switchover time | |
| Contact opening | 2 x 2.5 |
| Actuating speed with vertical actuating angle to switch axis | |
| - Min. Actuating speed | 1 |
| - Max. Actuating speed | 3 |
| - Actuating angle from left of switch axis | 30 |
| - Actuating angle from right of switch axis | 30 |

Ambient conditions

| | |
|----------------------------------|----------------------|
| Ambient temperature | |
| - Min. environmental temperature | -30 |
| - Max. environmental temperature | +90 |
| Protection class | IP65 to IEC/EN 60529 |

Electrical data

| | |
|--------------------------------|---|
| Design of control element | Normally open contact (NO), Opener (NC) |
| - with double break | |
| Switching principle | Creep circuit element |
| - positive break NC contact | |
| Number of shutters | 1 |
| Number of openers | 3 |
| Rated insulation voltage U_i | 500 V |
| Thermal test current I_{the} | 10 A |
| Utilisation category | AC-15: 400 V / 4 A |
| Max. fuse rating | 20 A gG D-fuse |



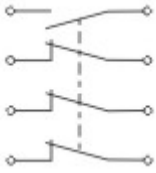

Dimensions

| | |
|--------------------------|-----|
| Dimensions of the sensor | |
| - Width of sensor | 67 |
| - Height of sensor | 226 |
| - Length of sensor | 43 |
| Roller wide | 8 |
| Roller diameter | 36 |

Diagram



Note Diagram

-  positive break NC contact
-  active
-  no active
-  Normally-open contact
-  Normally-closed contact

Ordering suffix

The applicable ordering suffix is added at the end of the part number of the safety switch.

Order example: TV3H 017-13Y- **C**

| | |
|------------------|--|
| ...- C | Magnetic blow-out Blow-out magnets available to switch high DC currents Rated operating current/voltage I_e/U_e : 1 A / 220 V; 4 A / 24 V Utilisation category: DC-13 |
| ...- RMS | Available with metal roller |
| ...- 1164 | Splined shaft and lever available with 10° tothing |

Ordering code

| | |
|---------------------|--|
| (1)(2) 017-(3)Y-(4) | |
| (1) | |
| T | Slow action |
| M | Snap action |
| (2) | |
| S | Plunger S |
| 2S | Telescopic plunger 2S |
| K | Offset roller lever K |
| 2K | Rocking offset roller lever 2K |
| 3K | Angle roller lever 3K |
| 8H | Roller lever 8H |
| 7H | Roller lever 7H |
| 10H | Rod lever 10H |
| H | Roller lever H |
| 4H | Spring rod lever on shaft 4H |
| 2H | Leaf-spring lever 2H |
| 3H | Roller lever 3H |
| 9H | Rod lever 9H |
| 6H | Leaf-spring lever 6H |
| (3) | |
| 22 | 2 Normally open contact (NO) / 2 Opener (NC) |

| | |
|-----|--|
| 13 | 1 Normally open contact (NO) / 3 Opener (NC) |
| 31 | 3 Normally open contact (NO) / 1 Opener (NC) |
| (4) | |
| UE | Slow action with overlapping contacts |
| H | Slow action with staggered contacts |
| C | Magnetic blow-out |

Documents

Operating instructions and Declaration of conformity (nl) 95 kB, 20.07.2018

Code: mrlk_posi-allgemein_nl

Operating instructions and Declaration of conformity (ru) 133 kB, 09.07.2018

Code: mrlk_posi-allgemein_ru

Operating instructions and Declaration of conformity (es) 88 kB, 09.07.2018

Code: mrlk_posi-allgemein_es

Operating instructions and Declaration of conformity (en) 86 kB, 09.07.2018

Code: mrlk_posi-allgemein_en

Operating instructions and Declaration of conformity (cn) 138 kB, 09.07.2018

Code: mrlk_posi-allgemein_cn

Operating instructions and Declaration of conformity (it) 86 kB, 09.07.2018

Code: mrlk_posi-allgemein_it

Operating instructions and Declaration of conformity (jp) 285 kB, 09.07.2018

Code: mrlk_posi-allgemein_jp

Operating instructions and Declaration of conformity (pl) 118 kB, 09.07.2018

Code: mrlk_posi-allgemein_pl

Operating instructions and Declaration of conformity (fr) 85 kB, 09.07.2018

Code: mrlk_posi-allgemein_fr

Operating instructions and Declaration of conformity (pt) 86 kB, 09.07.2018

Code: mrlk_posi-allgemein_pt

Operating instructions and Declaration of conformity (de) 88 kB, 09.07.2018

Code: mrlk_posi-allgemein_de

Declaration of conformity (de) 93 kB, 27.03.2017

Code: konfi_mrl_tm015_de

Declaration of conformity (en) 91 kB, 07.11.2017

Code: konfi_mrl_tm015_en

CCC certification (en) 4 MB, 27.10.2017

Code: q_372p02

CCC certification (cn) 4 MB, 27.10.2017

Code: q_372p03

EAC certification (ru) 388 kB, 20.01.2016

Images

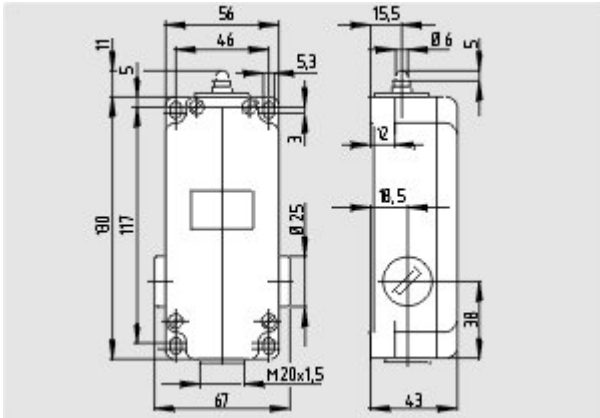

Dimensional drawing (basic component)

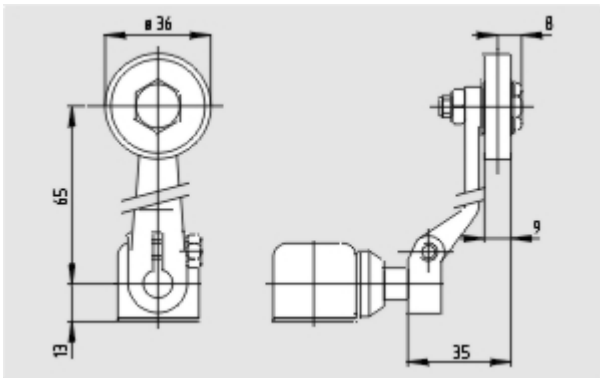

Dimensional drawing (miscellaneous)



Operating principle
