

## Datasheet - BN 65-10Z

Magnetic reed switch / BN 65

 Preferred typ

(Minor differences between the printed image and the original product may exist!)

- With pre-wired cable
- Non-contact principle
- Long life
- Actuation from side
- Actuating surface and direction of actuation marked by switch symbol
- with bias magnet
- Construction form Ø 13 mm
- Thermoplastic enclosure
- Actuating distance up to 60 mm depending on actuating magnet and version
- with central mounting

### Ordering details

Product type description	BN 65-10Z
Article number	101055787
EAN Code	4030661009469
eCl@ss	27-27-01-04

### Approval

Approval



### Global Properties

Permanent light	BN 65
Standards	-
Compliance with the Directives (Y/N) 	Yes
suitable for elevators (Y/N)	Yes
Mounting	central with threaded flange
Active principle	Magnetic drive
Materials	
- Material of the housings	Plastic, glass-fibre reinforced thermoplastic
- Material of the cable mantle	H03VV-F
Housing construction form	cylinder smooth
Weight	70
Recommended actuator	BP 10, 2 x BP 10, BP 15, 2 x BP 15, 2 x BP 15/2, BP 34, BP 20, BP 31,

- Lift switchgear

BP 11, BP 12, BP 21

BP 10, 2 x BP 10, 2 x BP 15/2, BP 15, 2 x BP 15, BP 34

## Mechanical data

---

Design of electrical connection	Cable
Cable length	1
Conductors	2 x 0,75
AWG-Number	18
Mechanical life	1.000.000.000 operations
Electrical lifetime	1.000.000 ... 1.000.000.000 operations
Switching frequency	300/
Actuating planes	Actuation from side
Switch distance	5 ... 50 BP 10 = 5 mm 2 x BP 10 = 17 mm BP 15 = 6 mm 2 x BP 15 = 17mm 2 x BP 15/2 = 17 mm BP 34 = 15 ... 20 mm BP 20 = 20 mm BP 31 = 20 mm BP 11 = 20 mm BP 12 = 10 ... 30 mm BP 21 = 25 ... 50 mm
- notice	Actuating distance up to 50 mm depending on actuating magnet and version  The specifications with regard to the switching distances apply to the actuation of the individually mounted devices without ferromagnetic influence. Any change of the distance, positive either negative, is possible due to ferromagnetic interference. When multiple actuating magnets are used, the mutual interference must be observed.
Type of actuation	Magnet
resistance to shock	30 g, on sine wave oscillation
resistant to vibration	30 g, on sine wave oscillation
Resistance to vibration	10 ... 55 HZ, Amplitude 1 mm
Bounce duration	0,3 ... 0,6; 3
Latching (Y/N)	No
bias magnet (Y/N)	Yes
Tightening torque for nuts	22 300
Actuating speed	18
Switching point accuracy	± 0,25 mm

## Ambient conditions

---

Ambient temperature	
- Min. environmental temperature	-25
- Max. environmental temperature	+75
Protection class	IP67 to IEC/EN 60529

## Electrical data

---

Design of control element	Normally open contact (NO)
Number of shutters	1
Number of openers	0
Switching time - Close	0,3 ... 1.5
Switching time - Open	-

Switch frequency	< 300
Dielectric strength	> 600 (50 )
Switching voltage	250
Switching current	3 A
Switching capacity	120

## Outputs

Design of control output	Reed kontakts
--------------------------	---------------

## LED switching conditions display

LED switching conditions display (Y/N)	No
--	----

## ATEX

Explosion protection categories for gases	None
Explosion protected category for dusts	None

## Dimensions

Dimensions of the sensor	
- Length of sensor	103
- Diameter of sensor	13

## notice

The opening and closing functions depend on the direction of actuation, the actuating magnets and the polarity of the actuating magnets. When the switches and actuators come together, the colours must coincide: Red (S) to red (S) and green (N) to green (N). This does not apply to the bistable contact.



## Included in delivery

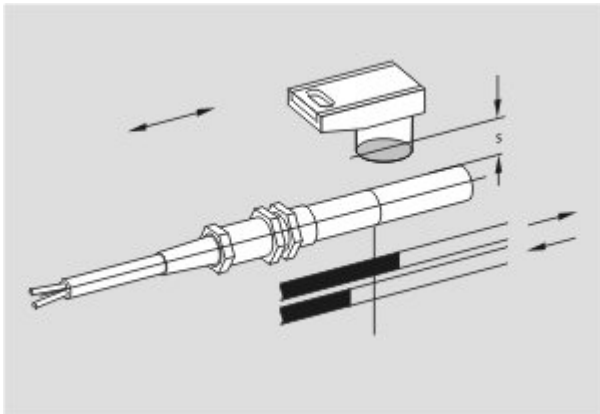

Actuators must be ordered separately.

## Diagram



Note Diagram

-  positive break NC contact
-  active
-  no active





-  Normally-open contact
-  Normally-closed contact

## Switch travel diagram

---



Notes Switch travel diagram

-  Contact closed
-  Contact open
-  Setting range
-  Break point
-  Positive opening sequence/- angle
- VS** adjustable range of NO contact
- VÖ** adjustable range of NC contact
- N** after travel

## Documents

---

**Declaration of conformity** (en) 186 kB, 12.07.2018

Code: \_\_bn\_p01\_en

**Declaration of conformity** (de) 102 kB, 08.06.2016

Code: \_\_bn\_p01

**notice - Switch distance** (de) 36 kB, 07.08.2009

Code: s\_bnbsp01

**notice - Switch distance** (nl) 39 kB, 07.08.2009

Code: s\_bnbsp04

**notice - Switch distance** (fr) 41 kB, 07.08.2009

Code: s\_bnbsp03

**notice - Switch distance** (pt) 39 kB, 07.08.2009

Code: s\_bnbsp10

**notice - Switch distance** (it) 40 kB, 07.08.2009

Code: s\_bnbsp05

**notice - Switch distance** (es) 38 kB, 07.08.2009

Code: s\_bnbsp09

## Images

---

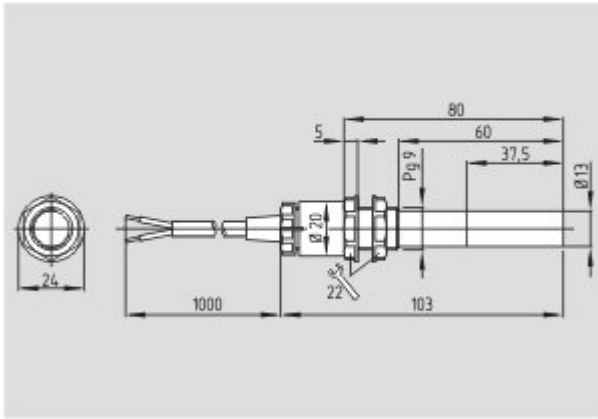

Dimensional drawing (basic component)

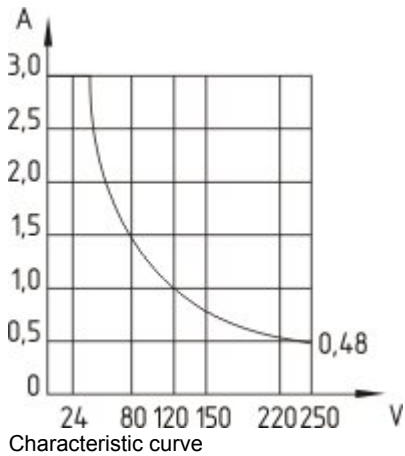

Characteristic curve

## System components

### Actuator

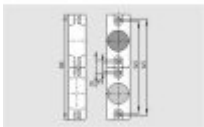

#### 101057432 - BP 22 N (S)

- -metal housing
- S-pole marked red
- N-pole marked green
- Suitable for mounting on ferrous material
- Can be used as N or S magnet

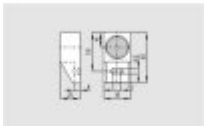

#### 101057534 - BP 21 S

- -metal housing
- S-pole marked red
- Suitable for mounting on ferrous material

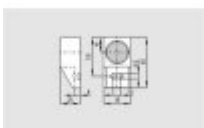

#### 101057536 - BP 21 N

- -metal housing
- N-pole marked green
- Suitable for mounting on ferrous material

#### 101059921 - BP 21

- -metal housing

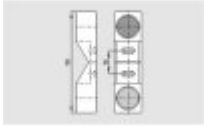

- S-pole marked red
- N-pole marked green
- Suitable for mounting on ferrous material

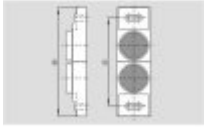

**101059917 - BP 12 N**

- -metal housing
- N-pole marked green
- Suitable for mounting on ferrous material

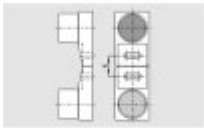

**101059916 - BP 12**

- -metal housing
- S-pole marked red
- N-pole marked green
- Suitable for mounting on ferrous material

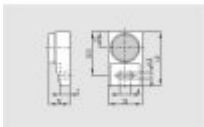

**101057533 - BP 11 S**

- -metal housing
- S-pole marked red
- Suitable for mounting on ferrous material

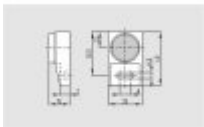

**101059923 - BP 11 N**

- -metal housing
- N-pole marked green
- Suitable for mounting on ferrous material

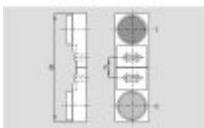

**101059922 - BP 11**

- -metal housing
- S-pole marked red
- N-pole marked green
- Suitable for mounting on ferrous material

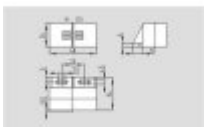

**101057521 - BP 31 S**

- thermoplastic enclosure
- S-pole marked red
- Suitable for mounting on ferrous material with a distance of 20 mm

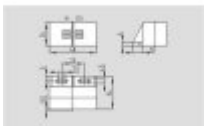

**101057520 - BP 31 N**

- thermoplastic enclosure
- N-pole marked green
- Suitable for mounting on ferrous material with a distance of 20 mm



#### 101057530 - BP 31

- thermoplastic enclosure
- S-pole marked red
- N-pole marked green
- Suitable for mounting on ferrous material with a distance of 20 mm

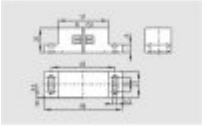

#### 101057541 - BP 20 S

- -metal housing
- S-pole marked red
- Suitable for mounting on ferrous material with a distance of 20 mm

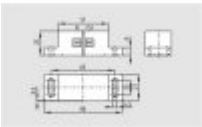

#### 101057538 - BP 20 N

- -metal housing
- N-pole marked green
- Suitable for mounting on ferrous material with a distance of 20 mm

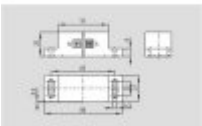

#### 101057549 - BP 20

- -metal housing
- S-pole marked red
- N-pole marked green
- Suitable for mounting on ferrous material with a distance of 20 mm

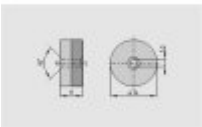

#### 101057553 - BP 34

- thermoplastic enclosure
- S-pole marked red
- N-pole marked green
- Suitable for mounting on ferrous material with a distance of 25 mm

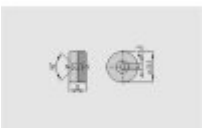

#### 101060163 - BP 15

- thermoplastic enclosure
- N-pole marked green
- S-pole marked red
- Suitable for mounting on ferrous material with a distance of 18 mm



#### 101057531 - BP 10

- Unenclosed
- Colour coding of poles by labels