

## Datasheet - SET SL 300-0120

Safety-related tactile sensor / Safety flaps / SL 300



- Robust design
- 2 Contacts
- Can be mounted on existing glue-spreading machines, veneering presses, etc.
- Various lengths available

(Minor differences between the printed image and the original product may exist!)

### Ordering details

Product type description	SET SL 300-0120
Article number	101181840
EAN Code	4030661316352
notice	The position switch with safety function is not included in delivery. The following alternatives are available: 1 Normally open contact (NO) / 1 Opener (NC) <b>T3K 335-11Z-U90</b> - Metal enclosure <b>T3K 336-11Z-U90</b> - Thermoplastic enclosure
eCl@ss	

### Global Properties

Permanent light	SL 300
Standards	EN 60947-5-1
Materials	
- Material of the profile strip	Aluminium
- Material of the side plates	Aluminium
- Material of the latching	Plastic, thermoplastic
Weight	

### Ambient conditions

Ambient temperature	
- Min. environmental temperature	-20
- Max. environmental temperature	+55
Storage and transport temperature	
- Min. Storage and transport temperature	-20
- Max. Storage and transport temperature	+70

Protection class

IP67 to IEC/EN 60529

## Electrical data

---

Design of control element

see switch description

Switching principle

see switch description

## Dimensions

---

Dimensions

- Width	100 mm
- Height	260 mm
- Length (L1)	120 mm

## Included in delivery

---

Supporting profile

Flap profile

Latching

Side plates

Mounting accessories

## Keywords

---

Keywords

Safety flaps T3K 335-11Z-U90 T3K 336-11Z-U90

## Indication legend

---

1	Supporting profile
2	Flap profile
3	Groove
4	Washer
5	Latching
6	Pin Ø 5 mm
7	Position switches with safety function ( <b>T3K 335-11Z-U90, T3K 336-11Z-U90</b> )
L1	Length Aluminium profile section

## Documents

---

**Mounting and wiring instructions** (de, en, fr) 48 kB, 30.01.2018

Code: m\_l30p01

## Images

---

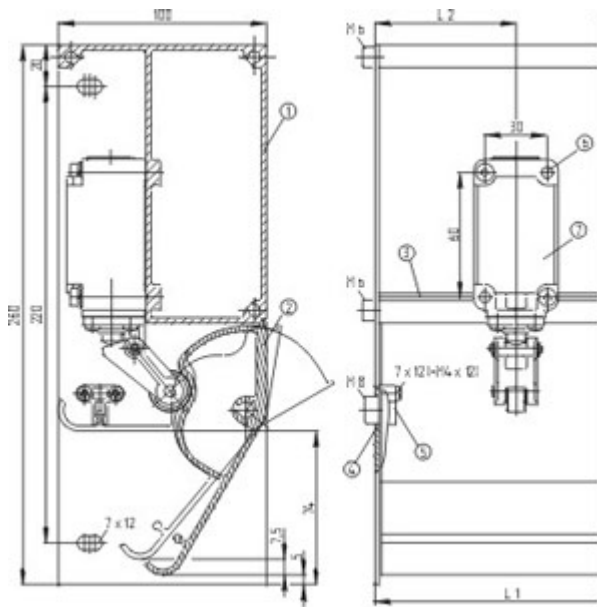

Dimensional drawing (basic component)

## System components

### Product



#### 101171823 - T3K 336-11Z-U90

- Design to EN 50041
- Actuation from bottom parallel to the switch, therefore only suitable for small housings.
- Thermoplastic enclosure
- Double-insulated
- Good resistance to oil and petroleum spirit
- Wide range of alternative actuators
- Actuator heads can be repositioned by 4 x 90°
- 1 Cable entry M 20 x 1.5
- Actuating head rotated by 90°



#### 101091759 - T3K 335-11Z-U90

- Metal enclosure
- Wide range of alternative actuators
- Good resistance to oil and petroleum spirit
- 40,5 mm x 76 mm x 38 mm
- Actuator heads can be repositioned by 4 x 90°
- 1 Cable entry M 20 x 1.5
- Actuating head rotated by 90°
- Design to EN 50041
- Actuation from bottom parallel to the switch, therefore only suitable for small housings.

K.A. Schmersal GmbH & Co. KG, Möddinghofe 30, D-42279 Wuppertal

The data and values have been checked thoroughly. Technical modifications and errors excepted.

Generiert am 13.02.2019 - 14:40:59h Kasbase 3.3.0.F.64I