

Datasheet - TV14H 236-20z



Position switch / 236 Thermoplastic enclosure - EN 50047 with Actuator / 236 Roller lever
14H

Preferred typ



(Minor differences between the printed image and the original product may exist!)

- Thermoplastic enclosure
- Good resistance to oil and petroleum spirit
- Wide range of alternative actuators
- 30 mm x 58,5 mm x 30 mm
- 1 Cable entry M 20 x 1.5
- Double-insulated
- Mounting details to EN 50047
- Actuator heads can be repositioned by 4 x 90°
- Lever angle adjustable in 10° steps

Ordering details

Product type description	TV14H 236-20Z
Article number	101101976
EAN Code	4030661071336
eCl@ss	27-27-26-01

Approval

Approval

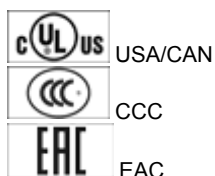

Classification

Standards	EN ISO 13849-1
Mission time notice	20 Years
	$MTTF_d = \frac{B_{10d}}{0,1 \times n_{op}}$
	$n_{op} = \frac{d_{op} \times h_{op} \times 3600 \text{ s/h}}{t_{cycle}}$

Global Properties

Permanent light	T 236 Rollenschwenkhebel 14 H
Standards	IEC 60947-5-1, ISO 13849-1, BG-GS-ET-15
Compliance with the Directives (Y/N) 	Yes
Suitable for safety functions (Y/N)	No
Materials	
- Material of the housings	Plastic, glass-fibre reinforced thermoplastic, self-extinguishing
- Lever material	Metal film
- Roller material	Plastic
- Material of the contacts	Silver
Housing coating	None
Housing construction form	Norm construction design
Weight	75

Mechanical data

Design of electrical connection	Screw connection
Cable section	
- Min. Cable section	0,75
- Max. Cable section	2.5
Mechanical life	20.000.000 operations
Switching frequency	max. 5000 /h
notice	All indications about the cable section are including the conductor ferrules.
Design of actuating element	Roller lever
actuating torque	min. 15 Ncm
Bounce duration	in accordance with actuating speed
Switchover time	in accordance with actuating speed
Positive break torque	18.5 Ncm
Actuating speed with actuating angle 30° to switch axis	
- Min. Actuating speed	4122 mm/min
- Max. Actuating speed	1 m/s

Ambient conditions

Ambient temperature	
- Min. environmental temperature	-30 °C
- Max. environmental temperature	+80 °C
Protection class	IP67

Electrical data

Design of control element	Normally open contact (NO)
Switching principle	Creep circuit element
Number of auxiliary contacts	2
Number of safety contacts	0
Rated impulse withstand voltage U_{imp}	6 kV
Rated insulation voltage U_i	500 V
Thermal test current I_{the}	10 A
Utilisation category	AC-15: 230 V / 4 A, DC-13: 24 V / 1 A
Required rated short-circuit current	1000 A
Max. fuse rating	6 A gG D-fuse

Dimensions

Dimensions of the sensor

- Width of sensor	30 mm
- Height of sensor	112 mm
- Length of sensor	46 mm

notice

Switch with 2 NO contacts are not for security tasks

Diagram



Note Diagram

- positive break NC contact
- active
- no active
- Normally-open contact
- Normally-closed contact

Switch travel diagram

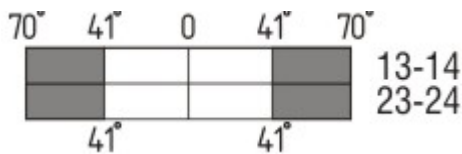

Notes Switch travel diagram

- Contact closed
 - Contact open
 - Setting range
 - Break point
 - Positive opening sequence/- angle
- VS** adjustable range of NO contact
VÖ adjustable range of NC contact
N after travel

Ordering suffix

The applicable ordering suffix is added at the end of the part number of the safety switch.

Order example: TV14H 236-20z-**1637**

....- 1637	0,3 µm gold-plated contacts
....- NPT	Cable entry NPT 1/2"
....- 1297	Enclosure with transverse slotted holes
....- ID	IDC method of termination

...RMS

Available with metal roller

...Z

Actuator head gasket

...ST

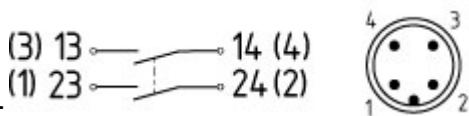

M12 connector with A-coding

Rated impulse withstand voltage U_{imp} : 0,8 kV

Rated insulation voltage U_i : 50 V

Operating current I_e : AC-15 50 V / 4 A

Caution! The versions with connector may only be used in PELV circuits to EN 60204-1.

...2310

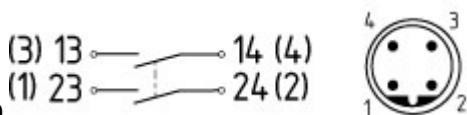

M12 connector with B-coding

Rated impulse withstand voltage U_{imp} : 0,8 kV

Rated insulation voltage U_i : 50 V

Operating current I_e : AC-15 50 V / 4 A

Caution! The versions with connector may only be used in PELV circuits to EN 60204-1.

Ordering code

(1)(2) 2(3)6-(4)Z(5)-(6)-(7)-(8)-(9)

(1)

Z

Snap action

T

Slow action

(2)

S

Plunger S

R

Roller plunger R

4S

Plunger 4S

4R

Roller plunger 4R

1R

Offset roller lever 1R

K

Offset roller lever K

3K

Angle roller lever 3K

4K

Angle roller lever 4K

K4

Angle roller lever K4

1H

Roller lever 1H

7H

Roller lever 7H

10H

Rod lever 10H

12H

Roller lever 12H

14H

Roller lever 14H

AF

Spring rod lever AF

(3)

3

slim design

5

large design

(4)

02

2 Opener (NC)

11

1 Normally open contact (NO) / 1 Opener (NC)

20

2 Normally open contact (NO), (Switch with 2 NO contacts are not for security tasks)

(5)

H

Slow action with staggered contacts

UE

Slow action with overlapping contacts

(6)		
<i>without</i>		Cable entry M20
ID		IDC method of termination
NPT		cable entry NPT 1/2"
ST		M12 connector with A-coding
ST-2310		M12 connector with B-coding
(7)		
1297		Enclosure with transverse slotted holes
(8)		
2138		Roller lever 7H for Position switches with safety function
(9)		
1637		gold-plated contacts

Documents

Operating instructions and Declaration of conformity (en) 160 kB, 15.06.2018

Code: mrlk_zt235_236_en

Operating instructions and Declaration of conformity (es) 161 kB, 21.06.2018

Code: mrlk_ZT235_236_es

Operating instructions and Declaration of conformity (de) 160 kB, 15.06.2018

Code: mrlk_ZT235_236_de

Operating instructions and Declaration of conformity (pl) 198 kB, 27.06.2018

Code: mrlk_ZT235_236_pl

Operating instructions and Declaration of conformity (nl) 162 kB, 15.06.2018

Code: mrlk_ZT235_236_nl

Operating instructions and Declaration of conformity (pt) 163 kB, 27.06.2018

Code: mrlk_ZT235_236_pt

Operating instructions and Declaration of conformity (it) 162 kB, 15.06.2018

Code: mrlk_ZT235_236_it

Operating instructions and Declaration of conformity (fr) 164 kB, 15.06.2018

Code: mrlk_ZT235_236_fr

Operating instructions and Declaration of conformity (cs) 194 kB, 25.01.2019

Code: mrlk_ZT235_236_cs

Declaration of conformity (es) 91 kB, 18.06.2018

Code: KAS_konfi_nsr_zt2xx-3xx_es

Declaration of conformity (pl) 130 kB, 18.06.2018

Code: KAS_konfi_nsr_zt2xx-3xx_pl

Declaration of conformity (it) 89 kB, 18.06.2018

Code: KAS_konfi_nsr_zt2xx-3xx_it

Declaration of conformity (pt) 90 kB, 18.06.2018

Code: KAS_konfi_nsr_zt2xx-3xx_pt

Declaration of conformity (fr) 89 kB, 18.06.2018

Code: KAS_konfi_nsr_zt2xx-3xx_fr

Declaration of conformity (de) 581 kB, 07.06.2018

Code: KAS_konfi_nsr_zt2xx-3xx_de

Declaration of conformity (en) 579 kB, 07.06.2018

Code: KAS_konfi_nsr_zt2xx-3xx_en

Declaration of conformity (nl) 89 kB, 18.06.2018

Code: KAS_konfi_nsr_zt2xx-3xx_nl

CCC certification (cn) 4 MB, 11.04.2018

Code: q_235p02

CCC certification (en) 4 MB, 27.10.2017

Code: q_235p01

EAC certification (ru) 844 kB, 05.10.2015

Code: q_6037p17_ru

Images

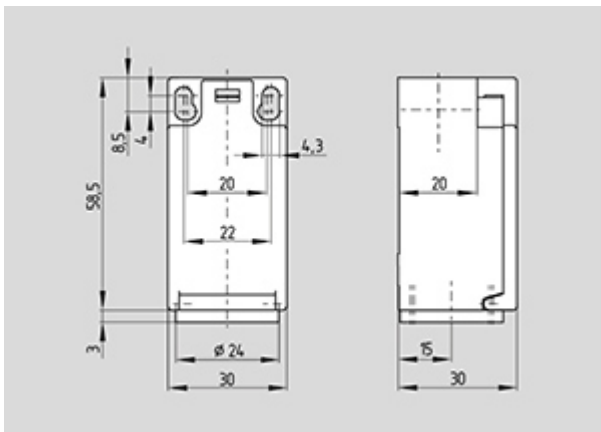

Dimensional drawing (basic component)

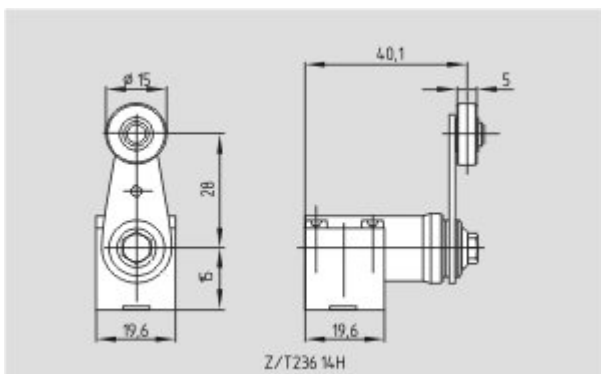

Dimensional drawing (actuator)

K.A. Schmersal GmbH & Co. KG, Mödinghofe 30, D-42279 Wuppertal

The data and values have been checked thoroughly. Technical modifications and errors excepted.

Generiert am 13.02.2019 - 13:19:43h Kasbase 3.3.0.F.64I