

## Datasheet - CSS-T-A

Accessories SD interface / SD junction boxes M12

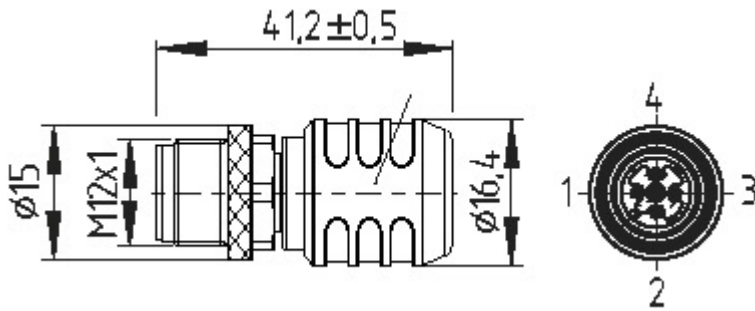

Preferred typ



- Accessories for series-wiring with serial diagnostics
- for CSS 34

(Minor differences between the printed image and the original product may exist!)

### Ordering details

Product type description	CSS-T-A
Article number	101190025
EAN Code	4030661355900
eCl@ss	27-27-24-91

### Global Properties

Permanent light	Abschlussstecker für T-Adapter
Connector	1 x Connector, 5-pole
Design	straight
Weight	15
Recommended combinations	Sensors

### Mechanical data

termination	M12
Bolting device	Screw locking

### Ambient conditions

Ambient temperature	
- Min. environmental temperature	-25
- Max. environmental temperature	+70

### Electrical data

Rated operating voltage $U_e$	30 VDC
Operating current $I_e$	2 A
Fuse rating for the operating voltage	2 A

### Dimensions

## Dimensions

- Width	16.5 mm
- Height	16.5 mm
- Length	43 mm



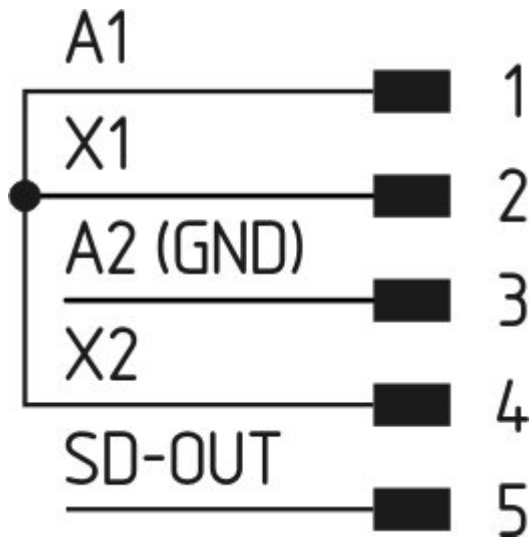

## notice

For the wiring, M12 cable extensions can be used. The voltage drop (due to the cable length, cable section, voltage drop per sensor) should be taken into account, as it reduces the maximum number of sensors that can be wired in series.

## Diagram



### Note Diagram

-  positive break NC contact
-  active
-  no active
-  Normally-open contact
-  Normally-closed contact

## Documents

**Mounting and wiring instructions** (de, en) 143 kB, 19.01.2018

Code: mrl\_cstp01\_de-en

## Images

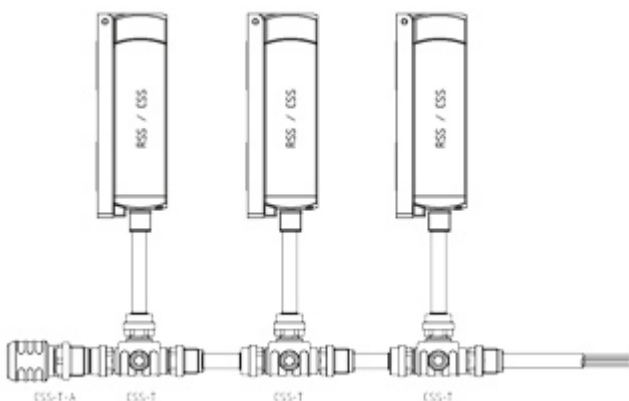

## System components

---

### Connector



#### V-SK8M12

- Interconnector
- 8-pole

---

K.A. Schmersal GmbH & Co. KG, Möddinghofe 30, D-42279 Wuppertal

The data and values have been checked thoroughly. Technical modifications and errors excepted.

Generiert am 13.02.2019 - 12:38:43h Kasbase 3.3.0.F.64l