

Datasheet - UV8H 434Y-3S/1OE



Position switch / medium heavy Position switch / Universal range U - Metal enclosure / U 434 / U 434 Roller lever 8H



- Metal enclosure
- 4 Contacts
- 62 mm x 127 mm x 50 mm (basic component)
- Switching points and contact function adjustable
- 3 cable entries M 20 x 1.5
- Actuator head can be repositioned in steps 4 x 90°
- Continuous adjustment of lever position 360°
- Lever can be transposed by 180°

(Minor differences between the printed image and the original product may exist!)

Ordering details

| | |
|--------------------------|------------------|
| Product type description | UV8H 434Y-3S/1OE |
| Article number | UV8H 434Y-3S/1OE |
| EAN Code | |
| eCl@ss | 27-27-06-01 |

Approval

Approval



Global Properties

| | |
|--|-----------------------------|
| Permanent light | U 434 Rollenschwenkhebel 8H |
| Standards | EN 60947-5-1 |
| Compliance with the Directives (Y/N)  | Yes |
| Suitable for safety functions (Y/N) | No |
| Standard housing (Y/N) | No |
| Materials | |
| - Material of the housings | light alloy die-casting |
| - Roller material | Plastic |
| - Material of the contacts | Silver |
| Housing coating | painted |

| | |
|------------|--------|
| Weight | 620 |
| Slide form | Castor |

Mechanical data

| | |
|--|---|
| Design of electrical connection | Screw connection |
| Cable section | |
| - Min. Cable section | 1.5 |
| - Max. Cable section | 2.5 |
| AWG-Number | 13 |
| Active principle | mechanical |
| Mechanical life | 10.000.000 operations |
| Contact life | 2.000.000 operations, at 6 A / 400 V, $\cos \varphi = 0,4$ |
| notice | All indications about the cable section are including the conductor ferrules. |
| Design of actuating element | Roller lever |
| Contact opening | 2 x 1.5 |
| Actuating speed with vertical actuating angle to switch axis | |
| - Min. Actuating speed | 1 |
| - Max. Actuating speed | 3 |
| - Actuating angle from left of switch axis | 30 |
| - Actuating angle from right of switch axis | 30 |

Ambient conditions

| | |
|----------------------------------|----------------------|
| Ambient temperature | |
| - Min. environmental temperature | -20 |
| - Max. environmental temperature | +60 |
| Protection class | IP65 to IEC/EN 60529 |

Electrical data

| | |
|--------------------------------|--|
| Design of control element | Opener (NC) Normally open contact (NO) |
| Switching principle | Creep circuit element |
| Number of shutters | 3 |
| Number of openers | 1 |
| Rated insulation voltage U_i | 500 V |
| Thermal test current I_{the} | 16 A |
| Max. fuse rating | 16 A gG D-fuse |

Dimensions

| | |
|--------------------------|-----|
| Dimensions of the sensor | |
| - Width of sensor | 62 |
| - Height of sensor | 178 |
| - Length of sensor | 50 |
| Roller wide | 8.5 |
| Roller diameter | 20 |

notice

Type of contact and switching points can be factory set to order.

Indication legend



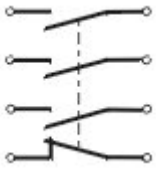

see drawing: Operating principle

Contact function, i. e. NC or NO contact, and switching points can be adjusted using a screwdriver

Diagram





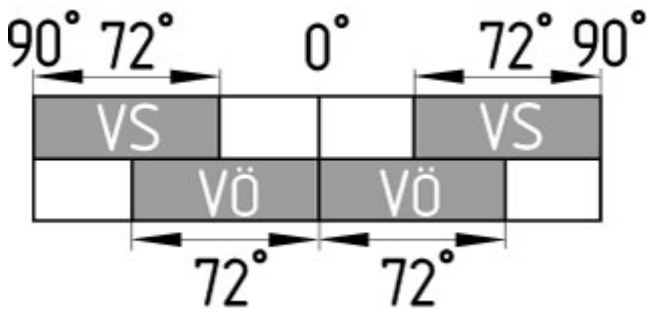

Note Diagram

-  positive break NC contact
-  active
-  no active
-  Normally-open contact
-  Normally-closed contact

Switch travel diagram



Notes Switch travel diagram

-  Contact closed
-  Contact open
-  Setting range
-  Break point
-  Positive opening sequence/- angle
- VS** adjustable range of NO contact
- VÖ** adjustable range of NC contact
- N** after travel

Ordering suffix

The applicable ordering suffix is added at the end of the part number of the safety switch.

Order example: UV8H 434Y-3S/1OE- 1272

...- 1272

Version for low temperatures to -30°C

...-RMS

Available with metal roller

...- 1164

Splined shaft and lever available with 10° tooting

Ordering code

U(1) 434Y-(2)-(3)

(1)

| | |
|-----|------------------------------|
| S | Plunger S |
| K | Offset roller lever K |
| 8H | Roller lever 8H |
| H | Roller lever H |
| 3H | Roller lever 3H |
| 7H | Roller lever 7H |
| 4H | Spring rod lever on shaft 4H |
| 9H | Rod lever 9H |
| 10H | Rod lever 10H |
| 2H | Leaf-spring lever 2H |
| 6H | Leaf-spring lever 6H |

(2)

| | |
|----------------|--|
| <i>without</i> | 2 Normally open contact (NO) / 2 Opener (NC) |
| 4OE | 4 Opener (NC) |
| 4S | 4 Normally open contact (NO) |
| 1S/3OE | 1 Normally open contact (NO) / 3 Opener (NC) |
| 3S/1OE | 3 Normally open contact (NO) / 1 Opener (NC) |

(3)

| | |
|------|---------------------------------------|
| 1272 | Version for low temperatures to -30°C |
|------|---------------------------------------|

Documents

Operating instructions and Declaration of conformity (nl) 95 kB, 20.07.2018

Code: mrlk_posi-allgemein_nl

Operating instructions and Declaration of conformity (ru) 133 kB, 09.07.2018

Code: mrlk_posi-allgemein_ru

Operating instructions and Declaration of conformity (es) 88 kB, 09.07.2018

Code: mrlk_posi-allgemein_es

Operating instructions and Declaration of conformity (en) 86 kB, 09.07.2018

Code: mrlk_posi-allgemein_en

Operating instructions and Declaration of conformity (cn) 138 kB, 09.07.2018

Code: mrlk_posi-allgemein_cn

Operating instructions and Declaration of conformity (it) 86 kB, 09.07.2018

Code: mrlk_posi-allgemein_it

Operating instructions and Declaration of conformity (jp) 285 kB, 09.07.2018

Code: mrlk_posi-allgemein_jp

Operating instructions and Declaration of conformity (pl) 118 kB, 09.07.2018

Code: mrlk_posi-allgemein_pl

Operating instructions and Declaration of conformity (fr) 85 kB, 09.07.2018

Code: mrlk_posi-allgemein_fr

Operating instructions and Declaration of conformity (pt) 86 kB, 09.07.2018

Code: mrlk_posi-allgemein_pt

Operating instructions and Declaration of conformity (de) 88 kB, 09.07.2018

Code: mrlk_posi-allgemein_de

Operating instructions (pl) 369 kB, 30.11.2018

Code: mrlk_u431-u434_pl

Operating instructions (en) 352 kB, 06.08.2018

Code: mrlk_u431-u434_en

Operating instructions (es) 350 kB, 08.08.2018

Code: mrlk_u431-u434_es

Operating instructions (nl) 365 kB, 12.11.2018

Code: mrlk_u431-u434_nl

Mounting and wiring instructions (de, en, fr) 209 kB, 17.03.2008

Code: m_43sp01

Operating instructions (de) 348 kB, 06.08.2018

Code: mrlk_u431-u434_de

Operating instructions (pt) 350 kB, 23.08.2018

Code: mrlk_u431-u434_pt

Declaration of conformity (en) 158 kB, 07.11.2017

Code: konfi_mrl_u43_en

Declaration of conformity (de) 128 kB, 07.11.2017

Code: konfi_mrl_u43_de

EAC certification (ru) 388 kB, 20.01.2016

Code: q_1527p17_ru

Images

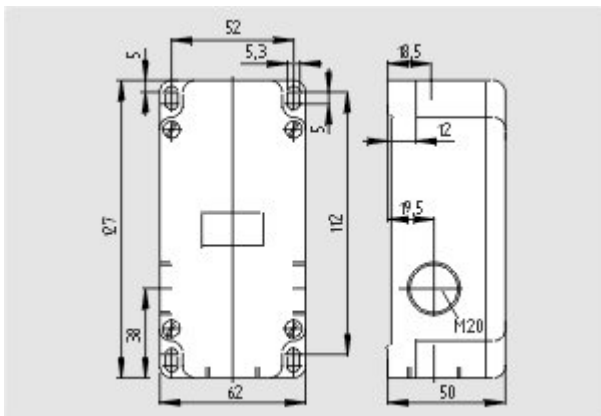

Dimensional drawing (basic component)

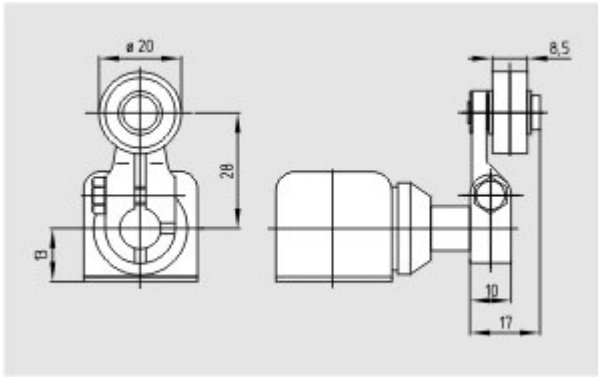

Dimensional drawing (miscellaneous)



Operating principle

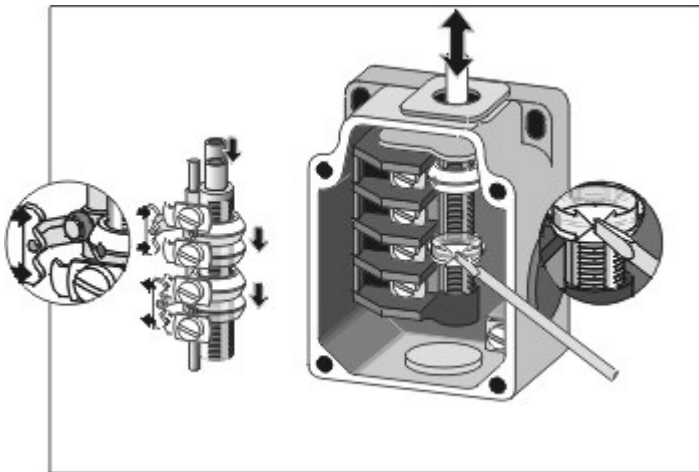

Operating principle

K.A. Schmersal GmbH & Co. KG, Mödinghofe 30, D-42279 Wuppertal

The data and values have been checked thoroughly. Technical modifications and errors excepted.

Generiert am 13.02.2019 - 13:45:11h Kasbase 3.3.0.F.64I