

Datasheet - ZR 256 STL-AS 2S



AS interface safety at work / Safety switchgear / Safety switches / 256 AS 2S / AS - 256 2S
Roller plunger r



- with integrated AS-i Safety electronics and with M12-connector socket to connect a second position switch
- AS-Interface M12 connector
- Thermoplastic enclosure
- Wide range of alternative actuators
- Good resistance to oil and petroleum spirit
- 87 mm x 50,5 mm x 31 mm
- Actuator heads can be repositioned by 4 x 90°
- Mounting details to EN 50047
- AS-Interface LED and status display
- Integrated AS-Interface
- Suitable for AS-i Power24

(Minor differences between the printed image and the original product may exist!)

Ordering details

Product type description	ZR 256 STL-AS 2S
Article number	ZR 256 STL-AS 2S
EAN Code	
eCl@ss	27-27-26-01

Approval

Approval



Classification

Application: Two position switches, dependent, on one safety guard:

Standards	EN ISO 13849-1, IEC 61508
PL	up e
Control category	up 4
PFH	2 x 10 ⁻⁸ /
- notice	up to max. 100000 switching cycles/year
SIL	up 3
Mission time	20 Years

Application: Each time one position switch, independent, on two safety guards:

Standards	EN ISO 13849-1, IEC 61508
-----------	---------------------------

PL	up c
Control category	up 1
PFH value	1.14 x 10 ⁻⁶ /
- notice	up to max. 100000 switching cycles/year
SIL	up 1
Mission time	20 Years

Global Properties

Permanent light	AS - 256 2S Rollendruckbolzen R
Standards	EN 50295, EN 60947-5-1, EN ISO 13849-1, IEC 61508
Compliance with the Directives (Y/N) 	Yes
Suitable for safety functions (Y/N)	Yes
Actuator type	C to EN 50047
Materials	
- Material of the housings	Plastic, glass-fibre reinforced thermoplastic, self-extinguishing
- Material of the connector	Plastic
- Material of the contacts	Silver
Housing coating	
Housing construction form	Norm construction design
Weight	

Mechanical data

Design of electrical connection	connector plug M12, 4-pole (AS-i connection) connector socket M12, 4-pole (2. switch)
connector	left () right (2. switch)
Mechanical life	1.000.000 operations
Switching frequency	5000
Design of actuating element	Roller plunger
Actuating force	9
restistance to shock	30 / 11
Resistance to vibration	10 ... 150, Amplitude 0,35 / 5
Positive break force	19
Actuating speed for vertical actuation	
- Max. Actuating speed	1

Ambient conditions

Ambient temperature	
- Min. environmental temperature	-25
- Max. environmental temperature	+60
- Min. Storage and transport temperature	-25
- Max. Storage and transport temperature	+85
Relative humidity	30 ... 95
- non-condensing	
- non-icing	
Protection class	IP67 to IEC/EN 60529
Protection rating	II

Electrical data

Design of control element	Opener (NC)
---------------------------	-------------

Switching principle	Snap switch element
- positive break NC contact 	
Number of auxiliary contacts	0
Number of safety contacts	2
Rated impulse withstand voltage	800
Rated insulation voltage	32
Thermal test current	10 A
Utilisation category	AC-15: 230 V / 4 A, DC-13: 24 V / 1 A
Max. fuse rating	6 A gG D-fuse

Electrical data - AS interface

AS-i Supply voltage	18 ... 31.6 VDC, Protection against polarity reversal
AS-i operating current	≤ 50
AS-i Device insulation	internally short-circuit proof
AS-i Specification	
- version	V 3.0
- Profile	S-0.B.F.F
AS-i Inputs	
- Channel 1	Data bits DI 0/DI 1= dynamic code transmission (Z/T 256 AS)
- Channel 2	Data bits DI 2/DI 3= dynamic code transmission (2. switch)
AS-i Outputs	DO 0 ... DO 3 not used
AS-i Parameter bits	P1 ... P3 not used
- P0	Channel 2 switched, switching condition 2. switch
AS-i input module address	0
- Default on address 0, programmable via the AS-Interface Master or Hand-held programming device	

LED switching conditions display

LED switching conditions display (Y/N)	Yes
AS-i LED switching conditions display	
(1) yellow LED	Channel 1 / AS-i SaW Bit 0,1
(2) green/red LED (AS-i duo LED)	Supply voltage / Communication error / slave address = 0
(3) yellow LED	Channel 2 / AS-i SaW Bit 2,3

ATEX

Explosion protection categories for gases	None
Explosion protected category for dusts	None

Dimensions

Dimensions of the sensor	
- Width of sensor	87
- Height of sensor	73
- Length of sensor	31

Pin assignment



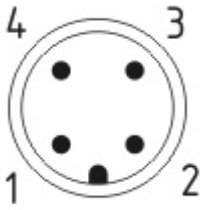

Connector	
1	AS interface +
2	None
3	AS interface -

connector socket 2. switch

Diagram





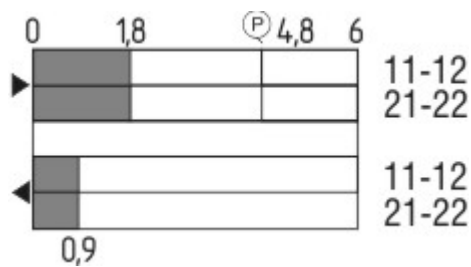

Note Diagram

-  positive break NC contact
-  active
-  no active
-  Normally-open contact
-  Normally-closed contact

Switch travel diagram



Notes Switch travel diagram

-  Contact closed
-  Contact open
-  Setting range
-  Break point
-  Positive opening sequence/- angle
- VS** adjustable range of NO contact
- VÖ** adjustable range of NC contact
- N** after travel

Ordering suffix

The applicable ordering suffix is added at the end of the part number of the safety switch.

Order example: ZR 256 STL-AS 2S-FKL

...-FKL

Connection for flat cable, left

Ordering code

(1)(2) 256 (3)-AS 2S

(1)

Z

Snap action

T

Slow action

(2)

S	Plunger S
R	Roller plunger R
1R	Offset roller lever 1R
K	Angle roller lever K
3K	Angle roller lever 3K
4K	Angle roller lever 4K
K4	Angle roller lever K4
1H	Roller lever 1H
12H	Roller lever 12H
14H	Roller lever 14H
7H	Roller lever 7H

(3)

STL	connector plug M12, left
FKL	Flat plug-in connector, left

Documents

Operating instructions and Declaration of conformity (da) 331 kB, 30.01.2018

Code: mrl_zt-256-as-2s_da

Operating instructions and Declaration of conformity (cs) 345 kB, 30.01.2018

Code: mrl_zt-256-as-2s_cs

Operating instructions and Declaration of conformity (es) 331 kB, 26.01.2018

Code: mrl_zt-256-as-2s_es

Operating instructions and Declaration of conformity (it) 328 kB, 30.01.2018

Code: mrl_zt-256-as-2s_it

Operating instructions and Declaration of conformity (pt) 332 kB, 26.01.2018

Code: mrl_zt-256-as-2s_pt

Operating instructions and Declaration of conformity (nl) 331 kB, 30.01.2018

Code: mrl_zt-256-as-2s_nl

Operating instructions and Declaration of conformity (en) 328 kB, 22.11.2017

Code: mrl_zt-256-as-2s_en

Operating instructions and Declaration of conformity (pl) 345 kB, 30.01.2018

Code: mrl_zt-256-as-2s_pl

Operating instructions and Declaration of conformity (jp) 385 kB, 13.08.2012

Code: mrl_zt-256-as-2s_jp

Operating instructions and Declaration of conformity (fr) 334 kB, 30.01.2018

Code: mrl_zt-256-as-2s_fr

Operating instructions and Declaration of conformity (de) 303 kB, 22.11.2017

Code: mrl_zt-256-as-2s_de

Images



Product photo

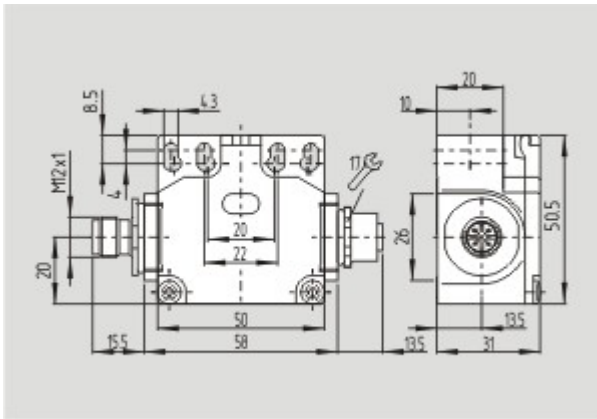

Dimensional drawing (basic component)

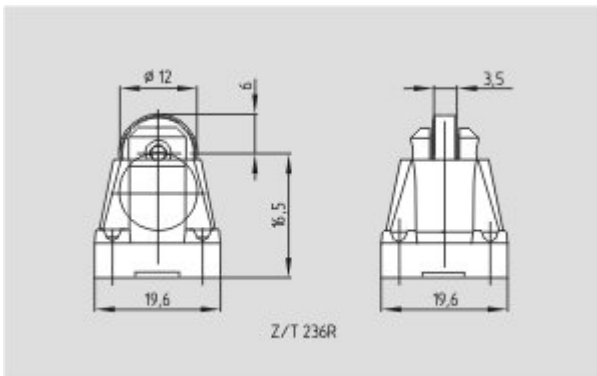

Dimensional drawing (actuator)

K.A. Schmersal GmbH & Co. KG, Möddinghofe 30, D-42279 Wuppertal

The data and values have been checked thoroughly. Technical modifications and errors excepted.

Generiert am 13.02.2019 - 12:43:14h Kasbase 3.3.0.F.64l