

Datasheet - BN 65-RZ/V

Magnetic reed switch / BN 65

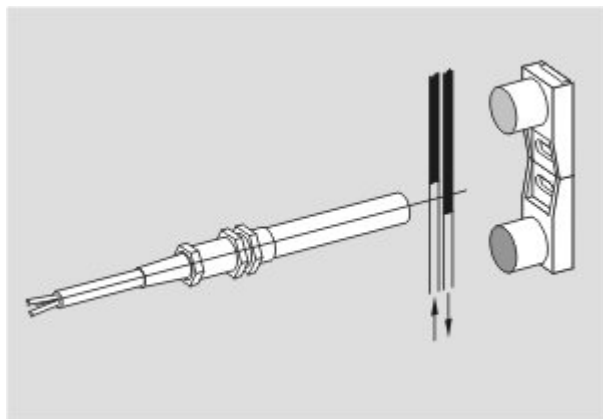

Preferred typ



(Minor differences between the printed image and the original product may exist!)

- With pre-wired cable
- Non-contact principle
- Long life
- Actuation from front
- Actuating surface and direction of actuation marked by switch symbol
- with bias magnet
- Construction form \varnothing 13 mm
- Thermoplastic enclosure
- Actuating distance up to 60 mm depending on actuating magnet and version
- with central mounting

Ordering details

Product type description	BN 65-RZ/V
Article number	101055838
EAN Code	4030661009933
eCl@ss	27-27-01-04

Approval

Approval



Global Properties

Permanent light	BN 65
Standards	-
Compliance with the Directives (Y/N) 	Yes
suitable for elevators (Y/N)	Yes
Mounting	central with threaded flange
Active principle	Magnetic drive
Materials	
- Material of the housings	Plastic, glass-fibre reinforced thermoplastic
- Material of the cable mantle	H03VV-F
Housing construction form	cylinder smooth
Weight	70
Recommended actuator	2 x BP 10, BP 34, BP 20, BP 31, BP 11, BP 12, BP 21, BP 22N, BP 22S, BE 20
- Lift switchgear	BP 10, 2 x BP 10, BP 15, BP 34

Mechanical data

Design of electrical connection	Cable
Cable length	1
Conductors	2 x 0,75
AWG-Number	18
Mechanical life	1.000.000.000 operations
Electrical lifetime	1.000.000 ... 1.000.000.000 operations
Switching frequency	200/
Actuating planes	front side
Switch distance	3 ... 45 2 x BP 10 = 3 mm BP 34 = 15 mm BP 20 = 10 mm BP 31 = 10 mm BP 11 = 15 mm BP 12 = 20 mm BP 21 = 45 mm BP 22N = 35 mm BP 22S = 35 mm BE 20 = 10 mm
- notice	Actuating distance up to 45 mm depending on actuating magnet and version The specifications with regard to the switching distances apply to the actuation of the individually mounted devices without ferromagnetic influence. Any change of the distance, positive either negative, is possible due to ferromagnetic interference. When multiple actuating magnets are used, the mutual interference must be observed.
Type of actuation	Magnet
resistance to shock	15 g, on sine wave oscillation
resistant to vibration	15 g, on sine wave oscillation
Resistance to vibration	10 ... 55 HZ, Amplitude 1 mm
Bounce duration	0,3 ... 0,6; 3
Latching (Y/N)	Yes
bias magnet (Y/N)	Yes
Tightening torque for nuts	22 300
Actuating speed	18
Switching point accuracy	± 0,25 mm

Ambient conditions

Ambient temperature	
- Min. environmental temperature	-25
- Max. environmental temperature	+75
Protection class	IP67 to IEC/EN 60529

Electrical data

Design of control element	bistable contact
Number of snap-in contacts	1
Switching time - Close	0,3 - 1.5
Switching time - Open	0,5
Switch frequency	< 300
Dielectric strength	> 600 (50)
Switching voltage	250
Switching current	3 A
Switching capacity	120 /

Outputs

Design of control output Reed kontakts

LED switching conditions display

LED switching conditions display (Y/N) No

ATEX

Explosion protection categories for gases None

Explosion protected category for dusts None

Dimensions

Dimensions of the sensor

- Length of sensor 103
- Diameter of sensor 13

notice

The opening and closing functions depend on the direction of actuation, the actuating magnets and the polarity of the actuating magnets.

When the switches and actuators come together, the colours must coincide: Red (S) to red (S) and green (N) to green (N).

This does not apply to the bistable contact.

notice The switch is to be mounted on iron with a non-magnetic layer of at least 20 mm.

Included in delivery

Actuators must be ordered separately.

Diagram

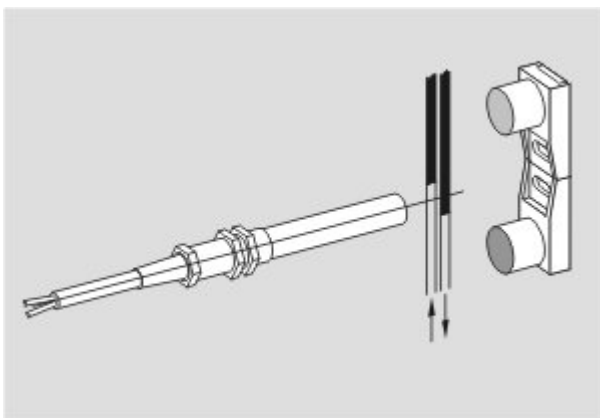

Note Diagram

⊖ positive break NC contact

⊕ active

⊖ no active





○ Normally-open contact

⊕ Normally-closed contact

Switch travel diagram



Notes Switch travel diagram

-  Contact closed
 -  Contact open
 -  Setting range
 -  Break point
 -  Positive opening sequence/- angle
- VS** adjustable range of NO contact
VÖ adjustable range of NC contact
N after travel

Documents

Declaration of conformity (en) 186 kB, 12.07.2018

Code: __bn_p01_en

Declaration of conformity (de) 102 kB, 08.06.2016

Code: __bn_p01

notice - Switch distance (de) 36 kB, 07.08.2009

Code: s_bnbsp01

notice - Switch distance (nl) 39 kB, 07.08.2009

Code: s_bnbsp04

notice - Switch distance (fr) 41 kB, 07.08.2009

Code: s_bnbsp03

notice - Switch distance (pt) 39 kB, 07.08.2009

Code: s_bnbsp10

notice - Switch distance (it) 40 kB, 07.08.2009

Code: s_bnbsp05

notice - Switch distance (es) 38 kB, 07.08.2009

Code: s_bnbsp09

Images

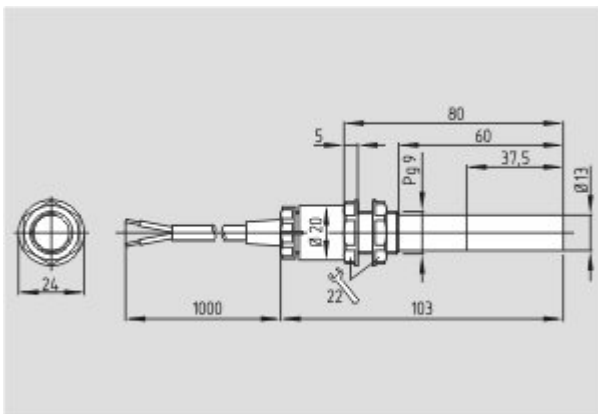

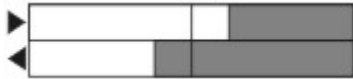

Switch travel diagram

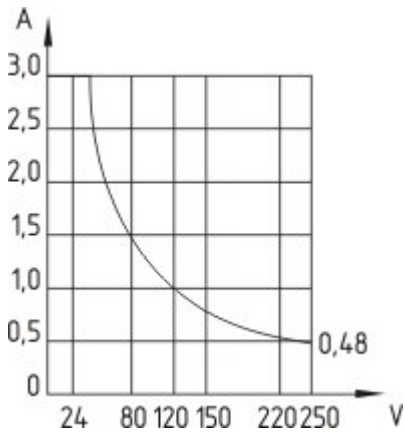

Characteristic curve

System components

Actuator

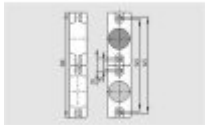

101057432 - BP 22 N (S)

- -metal housing
 - S-pole marked red
 - N-pole marked green
 - Suitable for mounting on ferrous material
 - Can be used as N or S magnet
-

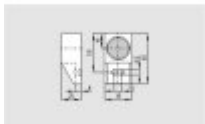

101057534 - BP 21 S

- -metal housing
 - S-pole marked red
 - Suitable for mounting on ferrous material
-

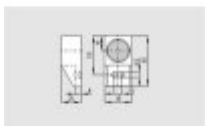

101057536 - BP 21 N

- -metal housing
 - N-pole marked green
 - Suitable for mounting on ferrous material
-

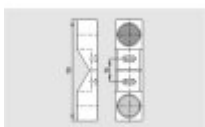

101059921 - BP 21

- -metal housing
 - S-pole marked red
 - N-pole marked green
 - Suitable for mounting on ferrous material
-

101059917 - BP 12 N

- -metal housing

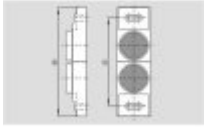

- N-pole marked green
- Suitable for mounting on ferrous material

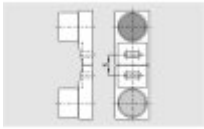

101059916 - BP 12

- -metal housing
- S-pole marked red
- N-pole marked green
- Suitable for mounting on ferrous material

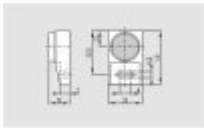

101057533 - BP 11 S

- -metal housing
- S-pole marked red
- Suitable for mounting on ferrous material

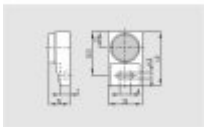

101059923 - BP 11 N

- -metal housing
- N-pole marked green
- Suitable for mounting on ferrous material

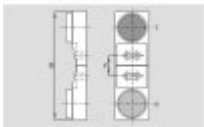

101059922 - BP 11

- -metal housing
- S-pole marked red
- N-pole marked green
- Suitable for mounting on ferrous material

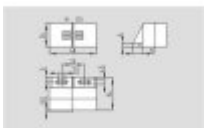

101057521 - BP 31 S

- thermoplastic enclosure
- S-pole marked red
- Suitable for mounting on ferrous material with a distance of 20 mm

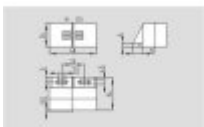

101057520 - BP 31 N

- thermoplastic enclosure
- N-pole marked green
- Suitable for mounting on ferrous material with a distance of 20 mm

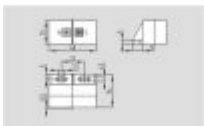

101057530 - BP 31

- thermoplastic enclosure
- S-pole marked red
- N-pole marked green
- Suitable for mounting on ferrous material with a distance of 20 mm

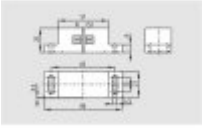

101057541 - BP 20 S

- -metal housing
- S-pole marked red
- Suitable for mounting on ferrous material with a distance of 20 mm

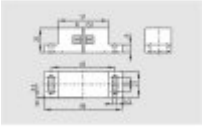

101057538 - BP 20 N

- -metal housing
- N-pole marked green
- Suitable for mounting on ferrous material with a distance of 20 mm

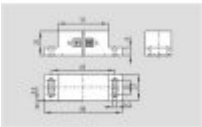

101057549 - BP 20

- -metal housing
- S-pole marked red
- N-pole marked green
- Suitable for mounting on ferrous material with a distance of 20 mm

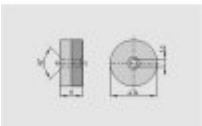

101057553 - BP 34

- thermoplastic enclosure
- S-pole marked red
- N-pole marked green
- Suitable for mounting on ferrous material with a distance of 25 mm

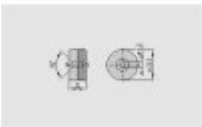

101060163 - BP 15

- thermoplastic enclosure
- N-pole marked green
- S-pole marked red
- Suitable for mounting on ferrous material with a distance of 18 mm



101057531 - BP 10

- Unenclosed
- Colour coding of poles by labels