

Datasheet - EX-T4VH 355-02ZH-3G/D



Position switches with safety function / EX-355 Metal enclosure with Actuator / EX-355 Roller lever H



(Minor differences between the printed image and the original product may exist!)

- Metal enclosure
- Wide range of alternative actuators
- Good resistance to oil and petroleum spirit
- 66,7 mm x 76 mm x 38 mm
- Actuator heads can be repositioned by 4 x 90°
- Including Ex-certified screwed cable gland and screw plug
- Mounting details to EN 50041
- 3 cable entries M 20 x 1.5
- Ex certified

Ordering details

Product type description	EX-T4VH 355-02ZH-3G/D
Article number	EX-T4VH 355-02ZH-3G/D
EAN Code	
eCl@ss	27-27-26-01

Approval

Approval



Classification

Standards	ISO 13849-1
B10d Normally-closed contact (NC)	20.000.000
Mission time notice	20 Years
	$MTTF_d = \frac{B_{10d}}{0,1 \times n_{op}}$ $n_{op} = \frac{d_{op} \times h_{op} \times 3600 \text{ s/h}}{t_{cycle}}$

Global Properties

Permanent light Standards	EX-T 355 Rollenschwenkhebel H IEC 60947-5-1, EN 60079-0, EN 60079-15, EN 60079-31, BG-GS-ET-15
---------------------------	---

Compliance with the Directives (Y/N) 	Yes
Suitable for safety functions (Y/N)	Yes
Actuator type	A to EN 50041
Materials	
- Material of the housings	light alloy die-casting
- Lever material	Metal film
- Material of the contacts	Silver
- Roller material	Plastic
Housing coating	painted
Housing construction form	Norm construction design
Weight	

Mechanical data

Design of electrical connection	Screw connection
Cable cross-section of the cable glands	
- Min. Cable cross-section of the cable glands	7
- Max. Cable cross-section of the cable glands	12
Cable section	
- Min. Cable section	0,75
- Max. Cable section	2.5
AWG-Number	13
Mechanical life	30.000.000 operations
Switching frequency	5000
notice	All indications about the cable section are including the conductor ferrules.
Design of actuating element	Roller lever
actuating torque	31
Bounce duration	< 2
Switchover time	in accordance with actuating speed
Impact energy	1
Actuating speed with actuating angle 30° to switch axis	
- Min. Actuating speed	
- Max. Actuating speed	2.5

Ambient conditions

Ambient temperature	
- Min. environmental temperature	-20
- Max. environmental temperature	+60
Protection class	IP67

Electrical data

Design of control element	Opener (NC)
Switching principle	Slow action with staggered contacts
- positive break NC contact 	
Number of auxiliary contacts	0
Number of safety contacts	2
Rated impulse withstand voltage	6
Rated insulation voltage	500
Thermal test current	10 A
Utilisation category	AC-15: 230 V / 4 A, DC-13: 24 V / 1 A
Max. fuse rating	6 A gG D-fuse

ATEX

EX-marking	EX II 3G Ex nC IIC T5 Gc X, EX II 3D Ex tc IIIC T90°C Dc X
Explosion protection categories for gases	ATEX gas ex-protection, Cat. 3
Explosion protection Zones for gases	2
Explosion protected category for dusts	ATEX dust ex-protection, Cat. 3
Explosion protection Zones for dusts	22

Dimensions

Dimensions of the sensor	
- Width of sensor	40.5
- Height of sensor	134
- Length of sensor	60.55



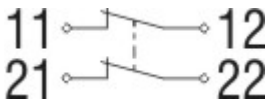

Keywords

Keywords	Ex, EEx, ATEX, Ex 235, Ex 235, 235 Ex, 235ex, 235ex, ATEX 235
----------	---

Diagram





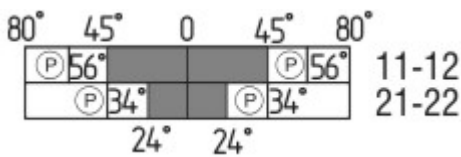

Note Diagram

-  positive break NC contact
-  active
-  no active
-  Normally-open contact
-  Normally-closed contact

Switch travel diagram



Notes Switch travel diagram

-  Contact closed
-  Contact open
-  Setting range
-  Break point
-  Positive opening sequence/- angle
- VS** adjustable range of NO contact
- VÖ** adjustable range of NC contact
- N** after travel

Ordering suffix

The applicable ordering suffix is added at the end of the part number of the safety switch.

Order example: EX-T4VH 355-02ZH-3G/D-RMS

....-RMS	Available with metal roller
....-1H	Roller material : Plastic Durchmesser : 25 mm
....-1297	Enclosure with transverse slotted holes
....-1637	0,3 µm gold-plated contacts

Documents

Operating instructions and Declaration of conformity (es) 373 kB, 24.01.2018

Code: mrl_ex-zt355_es

Operating instructions and Declaration of conformity (jp) 572 kB, 05.07.2011

Code: mrl_ex-zt355_jp

Operating instructions and Declaration of conformity (fr) 376 kB, 01.02.2018

Code: mrl_ex-zt355_fr

Operating instructions and Declaration of conformity (en) 380 kB, 11.01.2019

Code: mrl_ex-zt355_en

Operating instructions and Declaration of conformity (it) 371 kB, 16.02.2018

Code: mrl_ex-zt355_it

Operating instructions and Declaration of conformity (pl) 392 kB, 16.02.2018

Code: mrl_ex-zt355_pl

Operating instructions and Declaration of conformity (de) 337 kB, 11.01.2019

Code: mrl_ex-zt355_de

Operating instructions and Declaration of conformity (pt) 378 kB, 23.01.2018

Code: mrl_ex-zt355_pt

Operating instructions and Declaration of conformity (nl) 375 kB, 31.01.2018

Code: mrl_ex-zt355_nl

Brochure (de) 7 MB, 19.10.2016

Code: b_atep01_de

Brochure (en) 7 MB, 19.10.2016

Code: b_atep01_en

Brochure (it) 3 MB, 20.07.2007

Code: b_atep05

Images

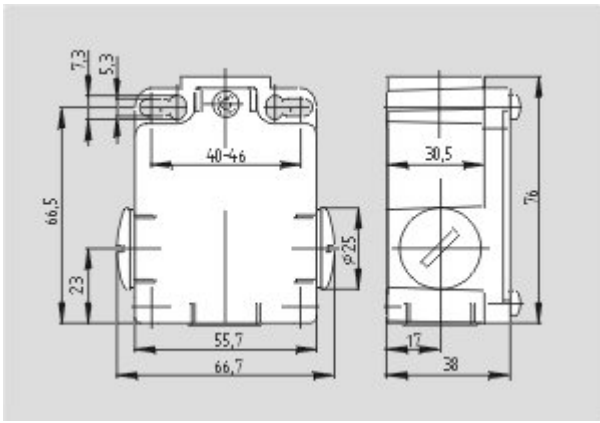

Dimensional drawing (basic component)

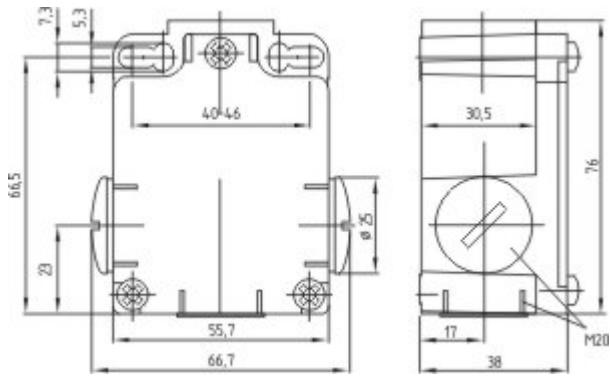

Dimensional drawing (basic component)

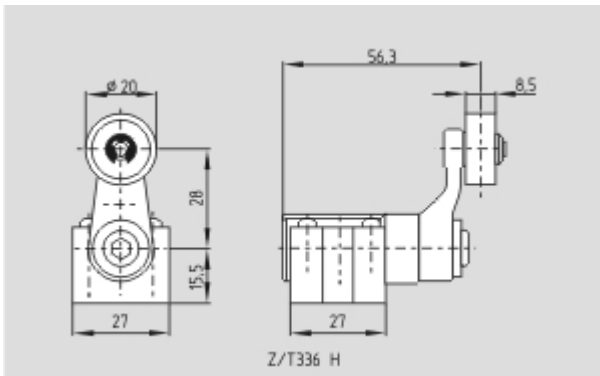

Dimensional drawing (actuator)