

Datasheet - AZ 15/16-B1-2024

Safety switch with separate actuator / AZ 16 / Actuator AZ 16



Preferred typ



(Minor differences between the printed image and the original product may exist!)

Ordering details

Product type description	AZ 15/16-B1-2024
Article number	101108276
EAN Code	4030661104263
eCl@ss	27-27-92-16

Global Properties

Permanent light	Gerader Betätiger B1-2024
Weight	23

Mechanical data

Design of actuators	straight, rigid
Minimum actuating radius	150

notice

Minimum actuating radius on hinged guards 150 mm

The axis of the hinge should be 11 mm above the top edge of the safety switch and in the same plane

Documents

Operating instructions and Declaration of conformity (fi) 101 kB, 02.07.2015

Code: mrl_az15-16-betaetiger_fi

Operating instructions and Declaration of conformity (es) 115 kB, 12.02.2014

Code: mrl_az15-16-betaetiger_es

Operating instructions and Declaration of conformity (it) 114 kB, 10.02.2014

Code: mrl_az15-16-betaetiger_it

Operating instructions and Declaration of conformity (de) 296 kB, 30.01.2014

Code: mrl_az15-16-betaetiger_de

Operating instructions and Declaration of conformity (cn) 137 kB, 30.06.2015

Code: mrl_az15-16-betaetiger_cn

Operating instructions and Declaration of conformity (nl) 114 kB, 11.03.2014

Code: mrl_az15-16-betaetiger_nl

Operating instructions and Declaration of conformity (pt) 115 kB, 23.05.2014

Code: mrl_az15-16-betaetiger_pt

Operating instructions and Declaration of conformity (jp) 165 kB, 11.08.2014

Code: mrl_az15-16-betaetiger_jp

Operating instructions and Declaration of conformity (en) 114 kB, 24.02.2014

Code: mrl_az15-16-betaetiger_en

Operating instructions and Declaration of conformity (pl) 155 kB, 11.03.2014

Code: mrl_az15-16-betaetiger_pl

Operating instructions and Declaration of conformity (fr) 114 kB, 14.04.2014

Code: mrl_az15-16-betaetiger_fr

Operating instructions and Declaration of conformity (sv) 113 kB, 17.06.2015

Code: mrl_az15-16-betaetiger_sv

Images

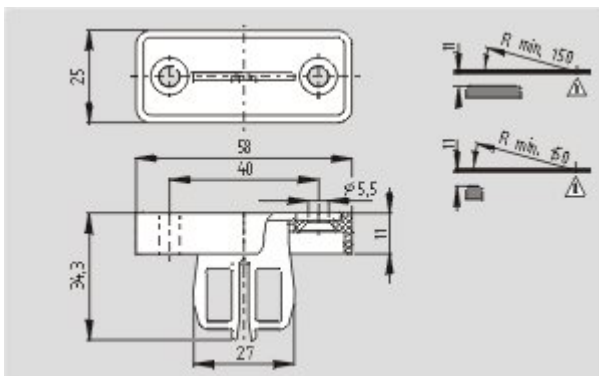

Dimensional drawing (actuator)

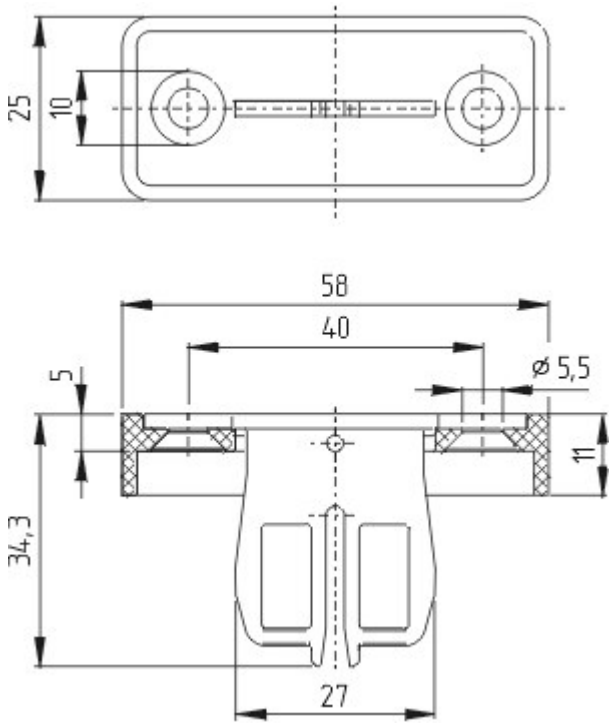

Dimensional drawing (miscellaneous)

K.A. Schmersal GmbH & Co. KG, Mödinghofe 30, D-42279 Wuppertal

The data and values have been checked thoroughly. Technical modifications and errors excepted.

Generiert am 13.02.2019 - 14:35:30h Kasbase 3.3.0.F.64I