

Datasheet - AZM 161SK-12/12RIED/TU-024-B1

Solenoid interlock / AZM 161I / AZM 161I-B1



(Minor differences between the printed image and the original product may exist!)

- Compact design
- Interlock with protection against incorrect locking.
- Individual coding
- Coding level "High" according to ISO 14119
- Double-insulated
- High holding force
- Long life
- 130 mm x 90 mm x 30 mm
- 1 Cable entry M 20 x 1.5
- Screw connection
- Manual release, cover-side
- Emergency exit
- Particularly suitable for sliding doors

Ordering details

Product type description	AZM 161SK-12/12RIED/TU-024-B1
Article number	101214462
EAN Code	4030661398792
eCl@ss	27-27-26-03

Approval

Approval

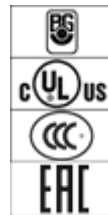

Classification

Standards	EN ISO 13849-1
B10d Normally-closed contact (NC)	2.000.000
Mission time	20 Years
notice	$MTTF_d = \frac{B_{10d}}{0,1 \times n_{op}}$ $n_{op} = \frac{d_{op} \times h_{cp} \times 3600 \text{ s/h}}{t_{cycle}}$

Global Properties

Permanent light	AZM 161I
Standards	EN 60947-5-1, BG-GS-ET-19
Compliance with the Directives (Y/N)	Yes
Number of actuating directions	3

Active principle	electromechanical
- Individual coding	
- Coding level "High" according to ISO 14119	
Duty cycle	Magnet 100
Materials	
- Material of the housings	glass-fibre reinforced thermoplastic, Plastic self-extinguishing,
- Material of the actuator	Stainless steel
- Material of the contacts	Silver
Housing coating	None
Weight	515

Mechanical data

Design of electrical connection	Screw connection
Cable section	
- Min. Cable section	1 x 0,25
- Max. Cable section	1 x 1.5, flexible
Mechanical life	> 1.000.000 operations
notice	All indications about the cable section are including the conductor ferrules.
Emergency unlocking device (Y/N)	Yes
Manual release (Y/N)	Yes
Emergency release (Y/N)	No
Latching force	30
Positive break force	20
positive break travel	10
Clamping force	2000
Max. Actuating speed	2
Minimum actuating radius	150
Actuating frequency	1000 /

Ambient conditions

Ambient temperature	
- Min. environmental temperature	-25
- Max. environmental temperature	+60
Protection class	IP67 to IEC/EN 60529

Electrical data

Design of control element	Normally open contact (NO), Opener (NC)
Switching principle	Creep circuit element
Number of auxiliary contacts	2
Number of safety contacts	4
Power to unlock	Yes
Power to lock	No
Rated control voltage	24 V/DC
Power consumption	10
Rated impulse withstand voltage	4
Rated insulation voltage	250
Thermal test current	6 A
Utilisation category	AC-15: 230 V / 4 A DC-13: 24 V / 2,5 A
Max. fuse rating	6 A gG D-fuse To DIN EN 60269-1

ATEX

Explosion protection categories for gases	None
Explosion protected category for dusts	None

Miscellaneous data

Applications

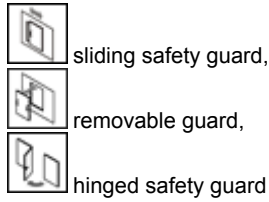

Dimensions

Dimensions of the sensor

- Width of sensor	130
- Height of sensor	90
- Length of sensor	30

notice

On hinged guards, minimum actuating radius at 90° to the plane of the actuator 180 mm
minimum actuating radius on hinged guards in line with the plane of the actuator 150 mm

The actuator is not available separately.

The axis of the hinge should be 5 mm above the top edge of the safety switch and in the same plane

Manual release

For manual release using M5 triangular key, available as accessory

- For maintenance, installation, etc.
- Top-side (ordering suffix -ED) or rear-side (ordering suffix -EU) mounting possible
- The emergency exit is used where an intervention in an already locked hazardous area is required
- Emergency exit by pressing the red push button

Included in delivery

Included in delivery



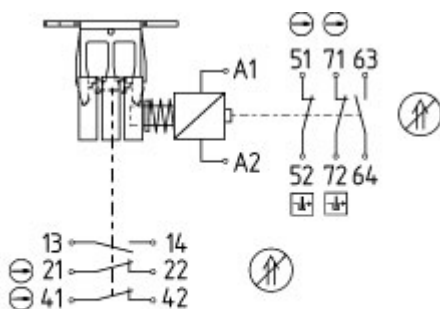

- Individually coded actuator
- tamperproof screws
- Slot sealing plugs

Diagram



13	14	21	22	41	42	51	52	63	64	71	72	A1	A2
----	----	----	----	----	----	----	----	----	----	----	----	----	----



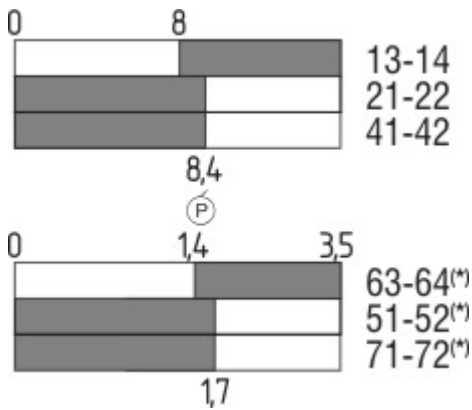

Note Diagram

-  positive break NC contact
-  active
-  no active
-  Normally-open contact
-  Normally-closed contact

Switch travel diagram



Notes Switch travel diagram

-  Contact closed
 -  Contact open
 -  Setting range
 -  Break point
 -  Positive opening sequence/- angle
- VS** adjustable range of NO contact
VÖ adjustable range of NC contact
N after travel

Ordering suffix

The applicable ordering suffix is added at the end of the part number of the safety switch.

Order example: AZM 161SK-12/12RIED/TU-024-B1-**1637**

....-**1637**

0,3 µm gold-plated contacts

Documents

Operating instructions and Declaration of conformity (en) 574 kB, 16.11.2017

Code: mrl_azm161i_en

Operating instructions and Declaration of conformity (jp) 767 kB, 12.04.2016

Code: mrl_azm161i_jp

Operating instructions and Declaration of conformity (nl) 620 kB, 29.11.2017

Code: mrl_azm161i_nl

Operating instructions and Declaration of conformity (da) 618 kB, 21.11.2017

Code: mrl_azm161i_da

Operating instructions and Declaration of conformity (de) 577 kB, 16.11.2017

Code: mrl_azm161i_de

Operating instructions and Declaration of conformity (pl) 648 kB, 29.11.2017

Code: mrl_azm161i_pl

Operating instructions and Declaration of conformity (es) 617 kB, 23.11.2017

Code: mrl_azm161i_es

Operating instructions and Declaration of conformity (pt) 623 kB, 29.11.2017

Code: mrl_azm161i_pt

Operating instructions and Declaration of conformity (sv) 619 kB, 29.11.2017

Code: mrl_azm161i_sv

Operating instructions and Declaration of conformity (cs) 640 kB, 21.11.2017

Code: mrl_azm161i_cs

Operating instructions and Declaration of conformity (it) 618 kB, 29.11.2017

Code: mrl_azm161i_it

Operating instructions and Declaration of conformity (fr) 624 kB, 23.11.2017

Code: mrl_azm161i_fr

EAC certification (ru) 809 kB, 05.10.2015

Code: q_6040p17_ru

Images



Product photo

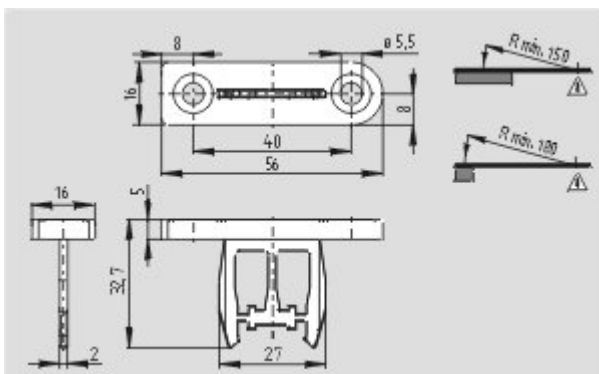

Dimensional drawing (miscellaneous)

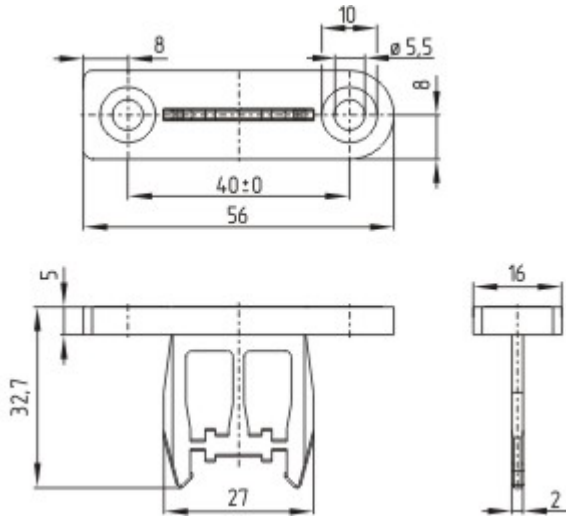

Dimensional drawing (miscellaneous)

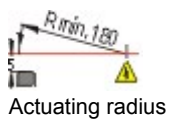

Actuating radius

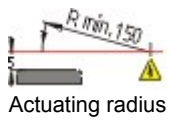

Actuating radius