

Datasheet - IFL 2-8M-01ST2P

Inductive proximity switch / Housing construction form: cylinder, thread / IFL - M8



- Design M 8 x 1
- Metal enclosure
- DC 3-wire
- miniature body
- Connector M8

(Minor differences between the printed image and the original product may exist!)

Ordering details

Product type description	IFL 2-8M-01ST2P
Article number	101117678
EAN Code	4030661047478
eCl@ss	27-27-01-01

Global Properties

Permanent light	IFL - M8
Standards	IEC/EN 60947-5-2; DIN VDE 0660-208
Compliance with the Directives (Y/N) 	Yes
Operating resource protection class	None
Materials	
- Material of the housings	Brass
- Material of the nuts	Brass
- Material of the active surface	Plastic
Housing coating	nickel-plated
Housing construction form	cylinder, thread
Weight	30

Mechanical data

Design of electrical connection	Connector M8
Conductor with strain relief	No

mechanical installation conditions	flush
Switch distance S_n	2 mm
Reduction factor 1 met (Y/N)	No
Protection circuit	inductive interference protection, Protection against polarity reversal, short-circuit and overload proof
Pressure resistant (Y/N)	No
Tightening torque for nuts	A/F 13 max. 600 Ncm

Ambient conditions

Ambient temperature	
- Min. environmental temperature	-25
- Max. environmental temperature	+70
Protection class	IP67 to IEC/EN 60529

Electrical data

Design of control element	Opener (NC)
Number of wire	3
Voltage type	DC, direct current
Supply voltage U_B	
- Min. supply voltage	10
- Max. supply voltage	30
Switch frequency	approx. 3000 HZ
Voltage drop U_d	approx. 1.2 V (200 mA)
Operating current I_e	200 mA
No-load current I_o	approx. 3.4 mA (24 V)

Outputs

Design of control output	PNP
--------------------------	-----

LED switching conditions display

LED switching conditions display (Y/N)	Yes
- yellow LED	

ATEX

Explosion protection categories for gases	None
Explosion protected category for dusts	None

Dimensions

Dimensions of the sensor	
- Length of sensor	54
- Diameter of sensor	M8



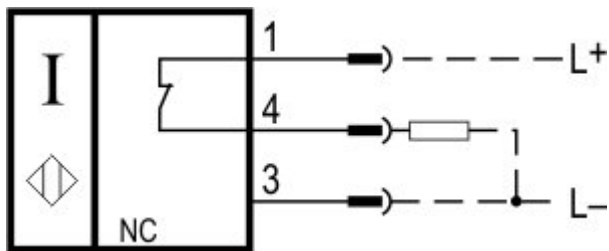

Indication legend

May not be charged in this area!

Diagram



Note Diagram

-  positive break NC contact
-  active
-  no active
-  Normally-open contact
-  Normally-closed contact

Ordering code

IFL (1)-(2)(3)-(4)(5)(6)(7)

<p>(1)</p> <p>2</p> <p>3</p> <p>B</p> <p>(2)</p> <p>8</p> <p>(3)</p> <p><i>without</i></p> <p>M</p> <p>(4)</p> <p>01</p> <p>10</p> <p>10/01</p> <p>11</p> <p>(5)</p> <p><i>without</i></p> <p>ST</p> <p>(6)</p> <p><i>without</i></p> <p>2</p> <p>(7)</p> <p>N</p> <p>P</p>	<p>Switch distance 2 mm</p> <p>Switch distance 3 mm</p> <p>Quasi-embeddable</p> <p>cylinder, thread M8</p> <p>Included in standard version Design miniature body</p> <p>Opener (NC)</p> <p>Normally open contact (NO)</p> <p>Normally open contact (NO) / Opener (NC) with Wiring compartment</p> <p>Normally open contact (NO) / Opener (NC) antivalent</p> <p>Cable</p> <p>Connector</p> <p>Included in standard version Plug-in connection</p> <p>Alternative Plug-in connection</p> <p>n-type</p> <p>p-type</p>
---	---

Documents

Operating instructions (nl) 134 kB, 01.08.2018

Code: mrl_ifl-allgemein_nl

Operating instructions (en) 128 kB, 31.08.2016

Code: mrl_ifl-allgemein_en

Operating instructions (pl) 137 kB, 21.10.2016

Code: mrl_ifl-allgemein_pl

Operating instructions (pt) 109 kB, 06.04.2017

Code: mrl_ifl-allgemein_pt

Operating instructions (it) 108 kB, 21.10.2016

Code: mrl_ifl-allgemein_it

Operating instructions (es) 110 kB, 21.10.2016

Code: mrl_ifl-allgemein_es

Operating instructions (cn) 177 kB, 05.05.2017

Code: mrl_ifl-allgemein_cn

Operating instructions (de) 131 kB, 31.08.2016

Code: mrl_ifl-allgemein_de

Operating instructions (fr) 110 kB, 21.10.2016

Code: mrl_ifl-allgemein_fr

Declaration of conformity (en) 91 kB, 13.04.2017

Code: konfi_ifl_en

Declaration of conformity (de) 96 kB, 01.07.2016

Code: konfi_ifl_de

Images

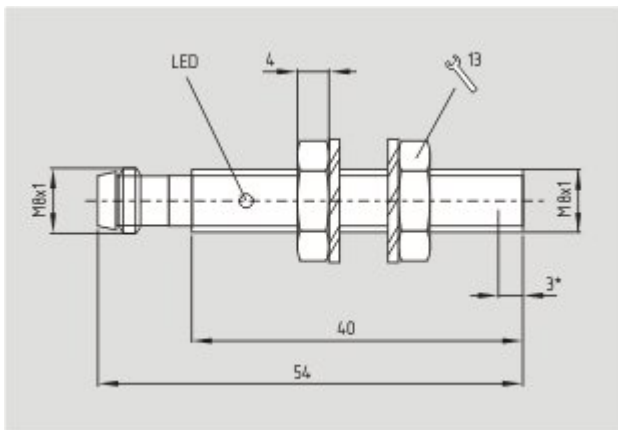

Dimensional drawing (basic component)

K.A. Schmersal GmbH & Co. KG, Möddinghofe 30, D-42279 Wuppertal

The data and values have been checked thoroughly. Technical modifications and errors excepted.

Generiert am 13.02.2019 - 13:08:31h Kasbase 3.3.0.F.64I