

Datasheet - ZR 256-11z



Position switch / Thermoplastic enclosure 256 - EN 50047 with Actuator / 256 Roller plunger
R

Preferred typ



- 2 cable entries M 20 x 1.5
- Snap action with constant contact pressure up to switching point
- Mounting details to EN 50047
- Thermoplastic enclosure
- Double-insulated
- 58 mm x 50,5 mm x 31 mm
- Good resistance to oil and petroleum spirit
- Wide range of alternative actuators
- Actuator heads can be repositioned by 4 x 90°

(Minor differences between the printed image and the original product may exist!)

Ordering details

| | |
|--------------------------|---------------|
| Product type description | ZR 256-11Z |
| Article number | 101160535 |
| EAN Code | 4030661190440 |
| eCl@ss | 27-27-26-01 |

Approval

Approval

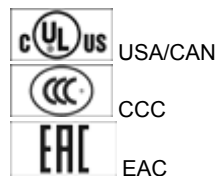

Classification

| | |
|-----------------------------------|--|
| Standards | ISO 13849-1 |
| B10d Normally-closed contact (NC) | 20.000.000 |
| Mission time | 20 Years |
| notice | $MTTF_d = \frac{B_{10d}}{0,1 \times n_{op}}$ $n_{op} = \frac{d_{op} \times h_{op} \times 3600 \text{ s/h}}{t_{cycle}}$ |

Global Properties

| | |
|--|---|
| Permanent light | Z 256 Rollendruckbolzen R |
| Standards | IEC 60947-5-1, ISO 13849-1, BG-GS-ET-15 |
| Compliance with the Directives (Y/N)  | Yes |
| Suitable for safety functions (Y/N) | Yes |
| Actuator type | C to EN 50047 |
| Materials | |
| - Material of the housings | Plastic, glass-fibre reinforced thermoplastic, self-extinguishing |
| - Material of the contacts | Silver |
| Housing coating | None |
| Housing construction form | Norm construction design |
| Weight | 85 |

Mechanical data

| | |
|---|---|
| Design of electrical connection | Screw connection |
| Cable section | |
| - Min. Cable section | 0,75 |
| - Max. Cable section | 2.5 |
| Mechanical life | 20.000.000 operations |
| Switching frequency | max. 5000 /h |
| notice | All indications about the cable section are including the conductor ferrules. |
| Design of actuating element | Roller plunger |
| Actuating force | min. 9 N |
| Bounce duration | < 3 |
| Switchover time | < 5.5 |
| Positive break force | 19 N |
| Actuating speed with actuating angle 30° to switch axis | |
| - Min. Actuating speed | 20 mm/min |
| - Max. Actuating speed | 1 m/s |

Ambient conditions

| | |
|----------------------------------|--------|
| Ambient temperature | |
| - Min. environmental temperature | -30 °C |
| - Max. environmental temperature | +80 °C |
| Protection class | IP67 |

Electrical data

| | |
|---|--|
| Design of control element | Normally open contact (NO), Opener (NC) |
| Switching principle | Snap switch element |
| - positive break NC contact  | |
| Number of auxiliary contacts | 1 |
| Number of safety contacts | 1 |
| Rated impulse withstand voltage U_{imp} | 6 kV |
| Rated insulation voltage U_i | 500 V |
| Thermal test current I_{the} | 10 A |
| Utilisation category | AC-15: 230 V / 4 A, DC-13: 24 V / 1 A |
| Required rated short-circuit current | 1000 A |
| Max. fuse rating | 6 A gG D-fuse |

Dimensions

Dimensions of the sensor

| | |
|--------------------|-------|
| - Width of sensor | 58 mm |
| - Height of sensor | 67 mm |
| - Length of sensor | 31 mm |

Diagram



Note Diagram

- positive break NC contact
- active
- no active
- Normally-open contact
- Normally-closed contact

Switch travel diagram

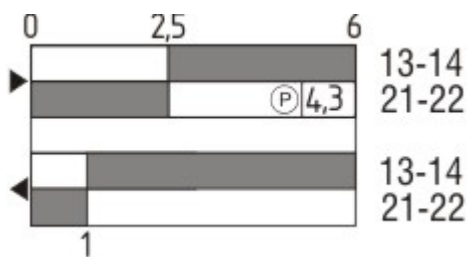

Notes Switch travel diagram

- Contact closed
- Contact open
- Setting range
- Break point
- Positive opening sequence/- angle
- VS** adjustable range of NO contact
- VÖ** adjustable range of NC contact
- N** after travel

Ordering suffix

The applicable ordering suffix is added at the end of the part number of the safety switch.

Order example: ZR 256-11z-1637

....-1637

0,3 µm gold-plated contacts

....-NPT

Cable entry NPT 1/2"

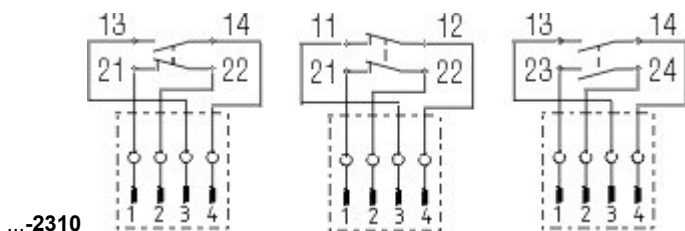

...-2310

M12 connector with B-coding

...-1297

Enclosure with transverse slotted holes

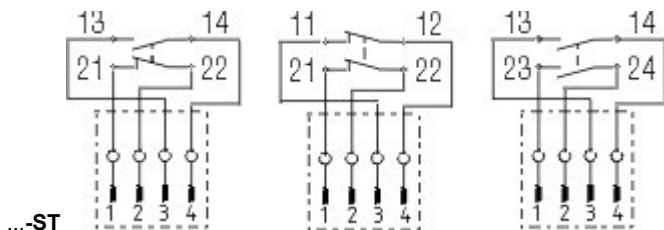

...-ST

M12 connector with A-coding

Ordering code

(1)(2) 2(3)6-(4)Z(5)-(6)-(7)-(8)-(9)

(1)

Z

Snap action

T

Slow action

(2)

S

Plunger S

R

Roller plunger R

4S

Plunger 4S

4R

Roller plunger 4R

1R

Offset roller lever 1R

K

Offset roller lever K

3K

Angle roller lever 3K

4K

Angle roller lever 4K

K4

Angle roller lever K4

1H

Roller lever 1H

7H

Roller lever 7H

10H

Rod lever 10H

12H

Roller lever 12H

14H

Roller lever 14H

AF

Spring rod lever AF

(3)

3

slim design

5

large design

(4)

02

2 Opener (NC)

11

1 Normally open contact (NO) / 1 Opener (NC)

20

2 Normally open contact (NO), (Switch with 2 NO contacts are not for security tasks)

(5)

H

Slow action with staggered contacts

UE

Slow action with overlapping contacts

(6)

without

Cable entry M20

| | |
|----------------|--|
| ID | IDC method of termination |
| NPT | cable entry NPT 1/2" |
| ST | M12 connector with A-coding |
| ST-2310 | M12 connector with B-coding |
| (7) | |
| 1297 | Enclosure with transverse slotted holes |
| (8) | |
| 2138 | Roller lever 7H for Position switches with safety function |
| (9) | |
| 1637 | gold-plated contacts |

Documents

Operating instructions and Declaration of conformity (en) 160 kB, 15.06.2018

Code: mrlk_zt235_236_en

Operating instructions and Declaration of conformity (es) 161 kB, 21.06.2018

Code: mrlk_ZT235_236_es

Operating instructions and Declaration of conformity (de) 160 kB, 15.06.2018

Code: mrlk_ZT235_236_de

Operating instructions and Declaration of conformity (pl) 198 kB, 27.06.2018

Code: mrlk_ZT235_236_pl

Operating instructions and Declaration of conformity (nl) 162 kB, 15.06.2018

Code: mrlk_ZT235_236_nl

Operating instructions and Declaration of conformity (pt) 163 kB, 27.06.2018

Code: mrlk_ZT235_236_pt

Operating instructions and Declaration of conformity (it) 162 kB, 15.06.2018

Code: mrlk_ZT235_236_it

Operating instructions and Declaration of conformity (fr) 164 kB, 15.06.2018

Code: mrlk_ZT235_236_fr

Operating instructions and Declaration of conformity (cs) 194 kB, 25.01.2019

Code: mrlk_ZT235_236_cs

Declaration of conformity (es) 91 kB, 18.06.2018

Code: KAS_konfi_nsr_zt2xx-3xx_es

Declaration of conformity (pl) 130 kB, 18.06.2018

Code: KAS_konfi_nsr_zt2xx-3xx_pl

Declaration of conformity (it) 89 kB, 18.06.2018

Code: KAS_konfi_nsr_zt2xx-3xx_it

Declaration of conformity (pt) 90 kB, 18.06.2018

Code: KAS_konfi_nsr_zt2xx-3xx_pt

Declaration of conformity (fr) 89 kB, 18.06.2018

Code: KAS_konfi_nsr_zt2xx-3xx_fr

Declaration of conformity (de) 581 kB, 07.06.2018

Code: KAS_konfi_nsr_zt2xx-3xx_de

Declaration of conformity (en) 579 kB, 07.06.2018

Code: KAS_konfi_nsr_zt2xx-3xx_en

Declaration of conformity (nl) 89 kB, 18.06.2018

Code: KAS_konfi_nsr_zt2xx-3xx_nl

CCC certification (cn) 4 MB, 11.04.2018

Code: q_235p02

CCC certification (en) 4 MB, 27.10.2017

Code: q_235p01

EAC certification (ru) 844 kB, 05.10.2015

Code: q_6037p17_ru

Images

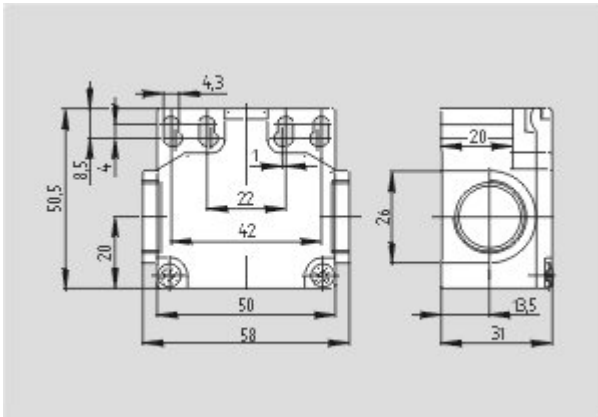

Dimensional drawing (basic component)

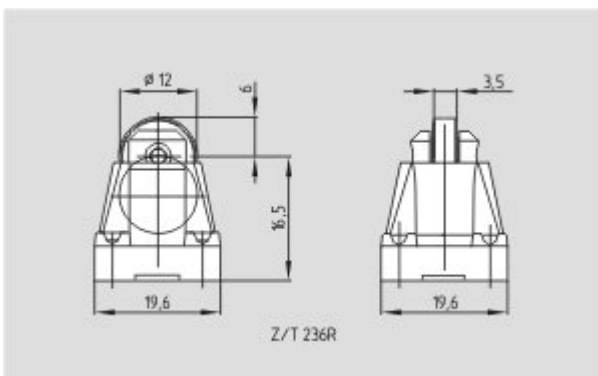

Dimensional drawing (actuator)

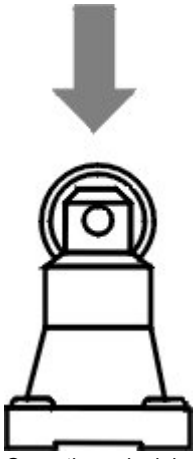

Operating principle

K.A. Schmersal GmbH & Co. KG, Möddinghofe 30, D-42279 Wuppertal
The data and values have been checked thoroughly. Technical modifications and errors excepted.
Generiert am 13.02.2019 - 14:00:03h Kasbase 3.3.0.F.64I