

Datasheet - TD 452-12Y

Position switch / medium heavy Position switch / T 452 / 452 Roller lever D



- Metal enclosure
- 118 mm x 127 mm x 64 mm (basic component)
- Actuator head can be repositioned in steps 4 x 90°
- Continuous adjustment of lever position 360°
- Lever can be transposed by 180°
- In temperature-resistant version, the roller can be mounted in two different positions on the shaft
- 2 cable entries M 25 x 1.5

(Minor differences between the printed image and the original product may exist!)

Ordering details

Product type description	TD 452-12Y
Article number	101059593
EAN Code	4030661036779
eCl@ss	27-27-06-01

Approval

Approval



Global Properties

Permanent light	452 Rollenschwenkhebel D
Standards	EN 60947-5-1
Compliance with the Directives (Y/N) 	Yes
Suitable for safety functions (Y/N)	No
Standard housing (Y/N)	No
Materials	
- Material of the housings	cast iron, galvanized
- Roller material	Plastic
- Material of the contacts	Silver
Housing coating	painted

Weight	2035
Slide form	Castor

Mechanical data

Design of electrical connection	Screw connection
Cable section	
- Min. Cable section	1.5
- Max. Cable section	2.5
AWG-Number	13
Active principle	mechanical
Mechanical life	10.000.000 operations
notice	All indications about the cable section are including the conductor ferrules.
Design of actuating element	Roller lever
Bounce duration	
Switchover time	
Contact opening	2 x 6
Actuating speed with vertical actuating angle to switch axis	
- Min. Actuating speed	1
- Max. Actuating speed	3
- Actuating angle from left of switch axis	30
- Actuating angle from right of switch axis	30

Ambient conditions

Ambient temperature	
- Min. environmental temperature	-30
- Max. environmental temperature	+90
Protection class	IP65 to IEC/EN 60529

Electrical data

Design of control element	Normally open contact (NO), Opener (NC)
- with double break	
Switching principle	Creep circuit element
- positive break NC contact	
Number of shutters	1
Number of openers	2
Rated impulse withstand voltage	6
Rated insulation voltage	400
Thermal test current	16 A
Utilisation category	AC-15: 400 V / 4 A
Max. fuse rating	16 A gG D-fuse

Dimensions

Dimensions of the sensor	
- Width of sensor	118
- Height of sensor	265
- Length of sensor	64
Roller wide	9
Roller diameter	36

Ordering suffix

The applicable ordering suffix is added at the end of the part number of the safety switch.

Order example: TD 452-12Y- **1276-2**

...- 1276-2	gold-plated contacts
...- 1801	Splined shaft and lever available with 10° tothing
...- H	Slow action with staggered contacts
...- UE	Slow action with overlapping contacts
...- RMS	Available with metal roller

Documents

Operating instructions and Declaration of conformity (nl) 95 kB, 20.07.2018

Code: mrlk_posi-allgemein_nl

Operating instructions and Declaration of conformity (ru) 133 kB, 09.07.2018

Code: mrlk_posi-allgemein_ru

Operating instructions and Declaration of conformity (es) 88 kB, 09.07.2018

Code: mrlk_posi-allgemein_es

Operating instructions and Declaration of conformity (en) 86 kB, 09.07.2018

Code: mrlk_posi-allgemein_en

Operating instructions and Declaration of conformity (cn) 138 kB, 09.07.2018

Code: mrlk_posi-allgemein_cn

Operating instructions and Declaration of conformity (it) 86 kB, 09.07.2018

Code: mrlk_posi-allgemein_it

Operating instructions and Declaration of conformity (jp) 285 kB, 09.07.2018

Code: mrlk_posi-allgemein_jp

Operating instructions and Declaration of conformity (pl) 118 kB, 09.07.2018

Code: mrlk_posi-allgemein_pl

Operating instructions and Declaration of conformity (fr) 85 kB, 09.07.2018

Code: mrlk_posi-allgemein_fr

Operating instructions and Declaration of conformity (pt) 86 kB, 09.07.2018

Code: mrlk_posi-allgemein_pt

Operating instructions and Declaration of conformity (de) 88 kB, 09.07.2018

Code: mrlk_posi-allgemein_de

Declaration of conformity (de) 94 kB, 08.08.2016

Code: __422p01

Declaration of conformity (pl) 129 kB, 08.08.2016

Code: __422p01_pl

Declaration of conformity (en) 84 kB, 29.11.2018

Code: __422p01_en

CCC certification (cn) 3 MB, 09.04.2018

Code: q_352p03

CCC certification (en) 3 MB, 09.04.2018

Code: q_352p02

EAC certification (ru) 388 kB, 20.01.2016

Code: q_1527p17_ru

Images

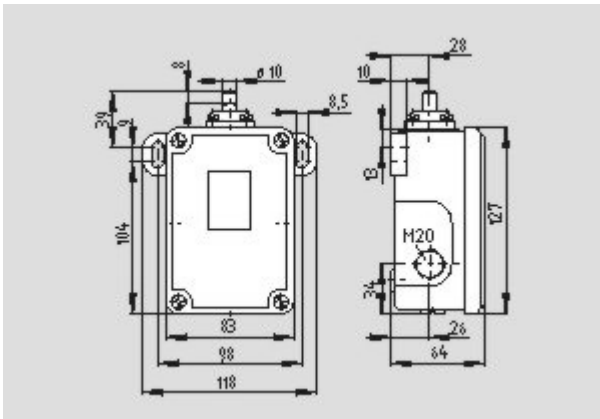

Dimensional drawing (basic component)

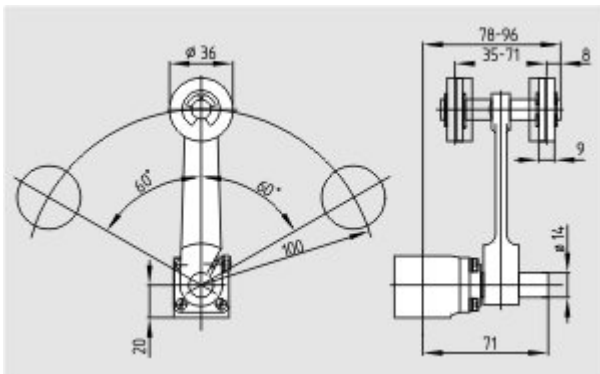

Dimensional drawing (miscellaneous)

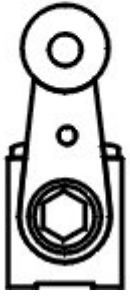

Operating principle

K.A. Schmersal GmbH & Co. KG, Möddinghofe 30, D-42279 Wuppertal
The data and values have been checked thoroughly. Technical modifications and errors excepted.
Generiert am 13.02.2019 - 13:39:01h Kasbase 3.3.0.F.64I