

Datasheet - M3S 330-11Y

Position switch / light Position switch / M 330 / M 330 Side plunger 3S



Preferred typ



- Metal enclosure
- Long life
- 40 mm x 76 mm x 40 mm (basic component)
- Suitable for low actuating speeds
- 1 Cable entry M 20 x 1.5
- free of silicon
- proved in power station applications
- with bellows to protect against heavy soiling
- Actuator heads can be repositioned by 4 x 90°

(Minor differences between the printed image and the original product may exist!)

Ordering details

Product type description	M3S 330-11Y
Article number	101168055
EAN Code	4030661220345
eCl@ss	27-27-06-01

Approval

Approval



Global Properties

Permanent light	M 330 Seitlicher Druckbolzen 3S
Standards	EN 60947-5-1
Compliance with the Directives (Y/N) 	Yes
Suitable for safety functions (Y/N)	No
Standard housing (Y/N)	No
Materials	
- Material of the housings	cast iron
- Material of the contacts	Silver
Housing coating	painted
Weight	240

Slide form

Sphere

Mechanical data

Design of electrical connection	Screw connection
Cable section	
- Min. Cable section	1.5
- Max. Cable section	2.5
AWG-Number	13
Active principle	mechanical
Mechanical life	> 30.000.000 operations
notice	All indications about the cable section are including the conductor ferrules.
Design of actuating element	Plunger
Actuating force	min. 17 N
resistance to shock	50 g / 6 ms
Bounce duration	≤ 1.5
Switchover time	≤ 10
Contact opening	2 x 0,5
Repeat accuracy of switching points	± 0,02
Actuating speed	
- Min. Actuating speed	1
- Max. Actuating speed	

Ambient conditions

Ambient temperature	
- Min. environmental temperature	-30
- Max. environmental temperature	+90
Protection class	IP65 to IEC/EN 60529

Electrical data

Design of control element	Normally open contact (NO), Opener (NC)
- Change-over contact with double break	
- galvanically separated contact bridges	
Switching principle	Snap switch element
Number of shutters	1
Number of openers	1
Rated impulse withstand voltage U_{imp}	4 kV
Rated insulation voltage U_i	250 V
Thermal test current I_{the}	6 A
Utilisation category	AC-15: 230 V / 2,5 A
Max. fuse rating	6 A gG D-fuse





Dimensions

Dimensions of the sensor	
- Width of sensor	62.7
- Height of sensor	103.5
- Length of sensor	40

Diagram





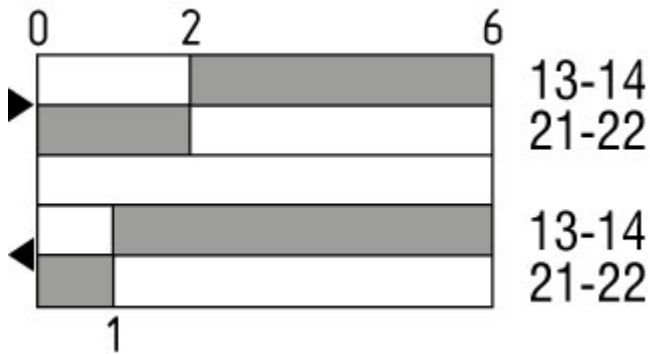

Note Diagram

-  positive break NC contact
-  active
-  no active
-  Normally-open contact
-  Normally-closed contact

Switch travel diagram



Notes Switch travel diagram

-  Contact closed
-  Contact open
-  Setting range
-  Break point
-  Positive opening sequence/- angle
- VS** adjustable range of NO contact
- VÖ** adjustable range of NC contact
- N** after travel

Ordering suffix

The applicable ordering suffix is added at the end of the part number of the safety switch.

Order example: M3S 330-11Y**Au-Ni**

...**Au-Ni**

Gold-nickel contact tips for low DC voltages

Ordering code

M(1) 330-11Y-(2)-(3)

(1)

- | | |
|-----------|------------------------|
| S | Plunger S |
| 2S | Telescopic plunger 2S |
| R | Roller plunger R |
| K | Offset roller lever K |
| 3K | Angle roller lever 3K |
| 3S | Side plunger 3S |
| 3R | Side roller plunger 3R |

AF	Spring rod lever AF
4D	Forked roller lever 4D
8H	Roller lever 8H
7H	Roller lever 7H
10H	Rod lever 10H
H	Roller lever H
4H	Spring rod lever on shaft 4H
2H	Leaf-spring lever 2H
3H	Roller lever 3H
9H	Rod lever 9H
6H	Leaf-spring lever 6H
(2)	
<i>without</i>	without LED switching conditions display
G24	with LED switching conditions display
(3)	
Ni	Contacts in Gold-nickel alloy
1164	Splined shaft and lever available with 10° toothing
1366	For temperatures up to +160°C

Documents

Operating instructions (pl) 152 kB, 07.08.2018

Code: mrlk_m330_pl

Operating instructions (de) 120 kB, 07.08.2018

Code: mrlk_m330_de

Operating instructions (nl) 122 kB, 07.08.2018

Code: mrlk_m330_nl

Operating instructions (fr) 122 kB, 07.08.2018

Code: mrlk_m330_fr

Operating instructions (pt) 121 kB, 07.08.2018

Code: mrlk_m330_pt

Operating instructions (en) 119 kB, 07.08.2018

Code: mrlk_m330_en

Operating instructions (it) 120 kB, 07.08.2018

Code: mrlk_m330_it

Operating instructions (es) 120 kB, 07.08.2018

Code: mrlk_m330_es

Declaration of conformity (en) 86 kB, 21.12.2016

Code: konfi_mrl_m330_en

Declaration of conformity (de) 97 kB, 17.11.2016

Code: konfi_mrl_m330_de

CCC certification (en) 808 kB, 02.08.2016

Code: q_332p01

CCC certification (cn) 803 kB, 02.08.2016

Code: q_332p02

EAC certification (ru) 844 kB, 05.10.2015

Code: q_6037p17_ru

Images

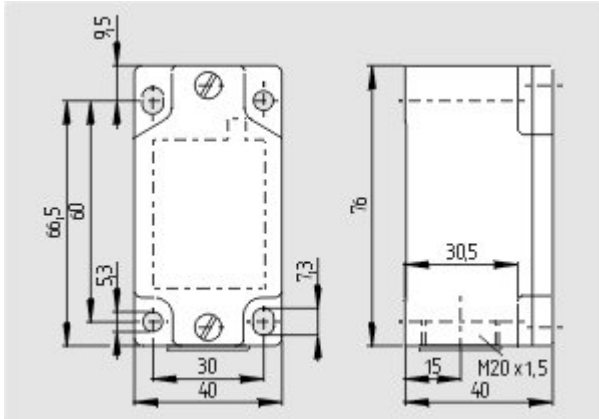

Dimensional drawing (basic component)

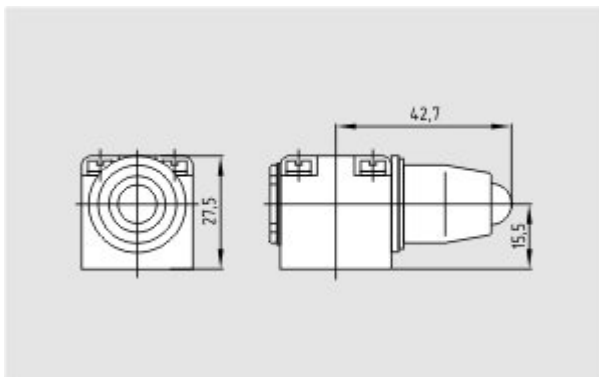

Dimensional drawing (miscellaneous)

K.A. Schmersal GmbH & Co. KG, Möddinghofe 30, D-42279 Wuppertal

The data and values have been checked thoroughly. Technical modifications and errors excepted.

Generiert am 13.02.2019 - 13:33:46h Kasbase 3.3.0.F.64l