

Datasheet - TK 236 ST-AS



AS interface safety at work / Safety switchgear / Safety switches / 236 AS / AS - 236 Offset roller lever K



- AS-Interface M12 connector
- Thermoplastic enclosure
- Wide range of alternative actuators
- Good resistance to oil and petroleum spirit
- 30 mm x 77 mm x 30 mm
- Actuator heads can be repositioned by 4 x 90°
- Mounting details to EN 50047
- AS-Interface LED and status display
- Integrated AS-Interface
- Suitable for AS-i Power24

(Minor differences between the printed image and the original product may exist!)

Ordering details

Product type description	TK 236 ST-AS
Article number	TK 236 ST-AS
EAN Code	
eCl@ss	27-27-26-01

Approval

Approval



Classification

Standards	EN ISO 13849-1, IEC 61508
PL	up c
Control category	up 1
PFH	1.14 x 10 ⁻⁶ /
- notice	up to max. 100000 switching cycles/year
SIL	up 1
Mission time	20 Years

If a fault exclusion for hazardous damage of the 1-channel mechanics is authorized and an adequate protection against tampering is ensured, suitable for use up to:

Standards	EN ISO 13849-1, IEC 61508
-----------	---------------------------

PL	up d
Control category	up 3
PFH value	1.01 x 10 ⁻⁷ /
- notice	up to max. 100000 switching cycles/year
SIL	up 2
Mission time	20 Years

Global Properties

Permanent light	AS - 236 Rollenhebel K
Standards	EN 50295, EN 60947-5-1, EN ISO 13849-1, IEC 61508
Compliance with the Directives (Y/N) 	Yes
Suitable for safety functions (Y/N)	Yes
Actuator type	E to EN 50047
Materials	
- Material of the housings	Plastic, glass-fibre reinforced thermoplastic, self-extinguishing
- Material of the connector	Plastic
- Material of the contacts	Silver
Housing coating	
Housing construction form	Norm construction design
Weight	

Mechanical data

Design of electrical connection	connector plug M12, 4-pole
Mechanical life	1.000.000 operations
Switching frequency	5000
Design of actuating element	Offset roller lever
Actuating force	9
restistance to shock	30 / 11
Resistance to vibration	10 ... 150, Amplitude 0,35 / 5
Positive break force	19
Actuating speed for vertical actuation	
- Max. Actuating speed	1

Ambient conditions

Ambient temperature	
- Min. environmental temperature	-25
- Max. environmental temperature	+60
- Min. Storage and transport temperature	-25
- Max. Storage and transport temperature	+85
Relative humidity	30 ... 95
- non-condensing	
- non-icing	
Protection class	IP67 to IEC/EN 60529
Protection rating	II

Electrical data

Design of control element	Opener (NC)
Switching principle	Creep circuit element
- positive break NC contact 	

Number of auxiliary contacts	0
Number of safety contacts	2
Rated impulse withstand voltage	800
Rated insulation voltage	32
Thermal test current	10 A
Utilisation category	AC-15: 230 V / 4 A, DC-13: 24 V / 1 A
Max. fuse rating	6 A gG D-fuse

Electrical data - AS interface

AS-i Supply voltage	18 ... 31.6 VDC, Protection against polarity reversal
AS-i operating current	≤ 50
AS-i Device insulation	internally short-circuit proof
AS-i Specification	
- version	V 3.0
- Profile	S-0.B.F.F
AS-i Inputs	
- Channel 1	Data bits DI 0/DI 1= dynamic code transmission
- Channel 2	Data bits DI 2/DI 3= dynamic code transmission
AS-i Outputs	DO 0 ... DO 3 not used
AS-i Parameter bits	P1 ... P3 not used
- P0	Channel 2 switched
AS-i input module address	0
- Default on address 0, programmable via the AS-Interface Master or Hand-held programming device	

LED switching conditions display

LED switching conditions display (Y/N)	Yes
AS-i LED switching conditions display	
(1) yellow LED	Channel 1 / AS-i SaW Bit 0,1
(2) green/red LED (AS-i duo LED)	Supply voltage / Communication error / slave address = 0
(3) yellow LED	Channel 2 / AS-i SaW Bit 2,3

ATEX

Explosion protection categories for gases	None
Explosion protected category for dusts	None

Dimensions

Dimensions of the sensor	
- Width of sensor	30
- Height of sensor	82.1
- Length of sensor	31



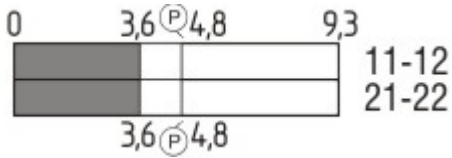

Pin assignment

1	AS interface +
2	None
3	AS interface -
4	None
5	Functional earth connection

Switch travel diagram



Notes Switch travel diagram

-  Contact closed
-  Contact open
-  Setting range
-  Break point
-  Positive opening sequence/- angle
- VS** adjustable range of NO contact
- VÖ** adjustable range of NC contact
- N** after travel

Ordering suffix

The applicable ordering suffix is added at the end of the part number of the safety switch.

Order example: TK 236 ST-AS-FK

...-FK

\$missingName\$

Ordering code

(1)(2) 236 (3)-AS

(1)

Z Snap action

T Slow action

(2)

S Plunger S

R Roller plunger R

1R Offset roller lever 1R

K Angle roller lever K

3K Angle roller lever 3K

4K Angle roller lever 4K

K4 Angle roller lever K4

1H Roller lever 1H

12H Roller lever 12H

14H Roller lever 14H

7H Roller lever 7H

(3)

ST connector plug M12, Plastic

FK Connection for flat cable

Documents

Operating instructions and Declaration of conformity (it) 309 kB, 09.10.2018

Code: mrl_zt235-236as_it

Operating instructions and Declaration of conformity (pt) 314 kB, 09.10.2018

Code: mrl_zt235-236as_pt

Operating instructions and Declaration of conformity (de) 320 kB, 09.10.2018

Code: mrl_zt235-236as_de

Operating instructions and Declaration of conformity (es) 312 kB, 09.10.2018

Code: mrl_zt235-236as_es

Operating instructions and Declaration of conformity (da) 301 kB, 09.10.2018

Code: mrl_zt235-236as_da

Operating instructions and Declaration of conformity (nl) 346 kB, 09.10.2018

Code: mrl_zt235-236as_nl

Operating instructions and Declaration of conformity (en) 313 kB, 09.10.2018

Code: mrl_zt235-236as_en

Operating instructions and Declaration of conformity (fr) 314 kB, 09.10.2018

Code: mrl_zt235-236as_fr

Operating instructions and Declaration of conformity (jp) 422 kB, 09.10.2018

Code: mrl_zt235-236as_jp

Operating instructions and Declaration of conformity (pl) 327 kB, 09.10.2018

Code: mrl_zt235-236as_pl

TÜV certification (de, en) 249 kB, 20.01.2017

Code: z_235p03

Images



Product photo

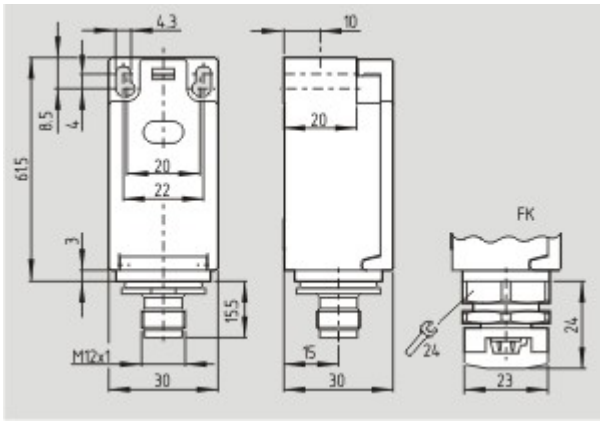

Dimensional drawing (basic component)

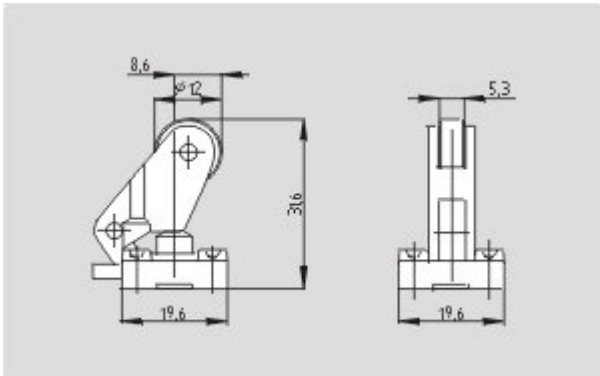

Dimensional drawing (actuator)

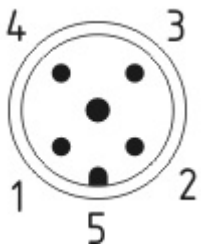

Contact arrangement

K.A. Schmersal GmbH & Co. KG, Möddinghofe 30, D-42279 Wuppertal

The data and values have been checked thoroughly. Technical modifications and errors excepted.

Generiert am 13.02.2019 - 12:41:35h Kasbase 3.3.0.F.64I