

Datasheet - SEPG 05.3.2.0.22/95

Two-hand control panels / SEPG 05.3



(Minor differences between the printed image and the original product may exist!)

- light alloy die-casting
- 2 part enclosure
- Stand and wall mounting possible
- Ergonomic operation
- The terminal blocks and relay can be mounted in the inner part
- Operating panel suitable for at least 8 additional command devices and indicator lights
- Holes drilled under the cover and central hole $\varnothing = 22,3\text{mm}$
- Emergency Stop button in metal version $\varnothing 49\text{ mm}$
- 2 black operating buttons (positioning parts) $\varnothing 42\text{ mm}$ in Metal film design

Ordering details

Product type description	SEPG 05.3.2.0.22/95
Article number	101172762
EAN Code	4250116202867
eCl@ss	27-37-12-19

Approval

Approval



Global Properties

Permanent light	SEPG 05.3
Standards	IEC/EN 60947-5-5, EN ISO 13850, EN 574
Compliance with the Directives (Y/N)	Yes
Number of operating push buttons (positioning parts)	2
- consisting of	EDP42SW; EF10.1; EF03.1
Number of Emergency Stop button	1
- consisting of	EDRR50RT; EFR; EF303.1
Materials	
- Material of the housings	Aluminium
Housing coating	powder-coated
Weight	4300
Suitable for EMERGENCY-OFF (Y/N)	Yes
Foot (Y/N)	No
Pre-wiring on terminal block (Y/N)	No
Stepped switching (Y/N)	No
Switching block (Y/N)	No
Construction kit possible (Y/N)	Yes
Recommended combinations	SRB201ZH, SRB200ZHX1, SRB201ZH3

Mechanical data

Connection type	Screw connection
Cable section	
- Min. Cable section	
- Max. Cable section	1.5
Mechanical life	10.000.000 operations

Ambient conditions

Protection class	IP65
------------------	------

Electrical data

Number of shutters	2
Number of openers	2
Rated insulation voltage	440
Thermal test current	10 A
Utilisation category	AC-15: 250 V / 8 A DC-13: 24 V / 5 A

Dimensions

Dimensions	
- Width	494 mm
- Height	184 mm
- Depth	160 mm
diameters for the actuating heads	
- Emergency stop latching pushbutton	49
- Operating push buttons (positioning parts)	42

notice

Customer-specific executions (completely pre-wired, special paint, etc.)

4 premachined predetermined breaking points (M25 x 1,5) for the cable gland outputs

1 NO/1 NC contact per unit, 1 NO/1 NC contact for Emergency-Stop

Central part suitable for fitting of up to 10 additional command devices and indicator lights (Ø 22 mm)

Optional: actuators with low actuating force

Keywords

Two-hand control panels

Documents

Operating instructions and Declaration of conformity (pt) 1 MB, 06.04.2017

Code: mrl_sep_pt

Operating instructions and Declaration of conformity (es) 1 MB, 16.02.2017

Code: mrl_sep_es

Operating instructions and Declaration of conformity (cn) 2 MB, 23.11.2018

Code: mrl_sep_cn

Operating instructions and Declaration of conformity (it) 1 MB, 29.06.2017

Code: mrl_sep_it

Operating instructions and Declaration of conformity (de) 1 MB, 11.01.2017

Code: mrl_sep_de

Operating instructions and Declaration of conformity (fr) 1 MB, 01.03.2017

Code: mrl_sep_fr

Operating instructions and Declaration of conformity (nl) 1 MB, 13.08.2018

Code: mrl_sep_nl

Operating instructions and Declaration of conformity (pl) 1 MB, 16.02.2017

Code: mrl_sep_pl

Operating instructions and Declaration of conformity (en) 1 MB, 11.01.2017

Code: mrl_sep_en

Images

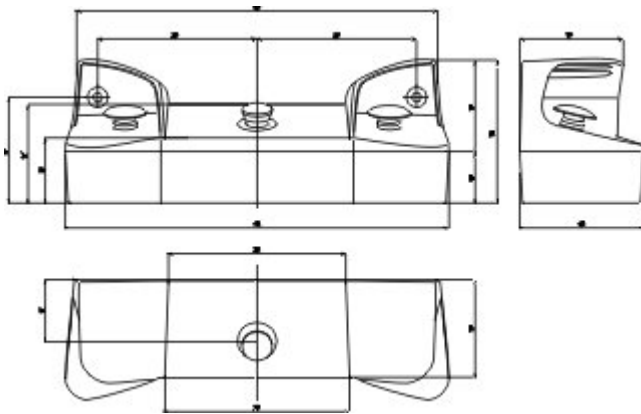

Dimensional drawing (basic component)

System components

Accessories



STPSK - \$missingName\$

- mobile sheet metal bending construction with threaded holes for floor fixation
- with height adjustment
- with Spacer ring
- can be combined with operating panel SEP... and foot switches with protective shields to be used as two-hand foot-operated station



STPLC - \$missingName\$

- Welding construction with threaded holes for floor fixation
- without height adjustment
- without Spacer ring
- can be combined with operating panel SEP... to be used as two-hand foot-operated station

STP 02.4 - \$missingName\$

- Welding construction with threaded holes for floor fixation



- with height adjustment
- with Spacer ring



STP 02.1 - \$missingName\$

- Welding construction with threaded holes for floor fixation
- with height adjustment
- without Spacer ring



STP 01.5 - \$missingName\$

- Welding construction with threaded holes for floor fixation
- without height adjustment
- Fixation of the spacer ring by the user through fixing and welding



STP 01.4 - \$missingName\$

- Welding construction with threaded holes for floor fixation
- without height adjustment
- with Spacer ring



STP 01.1 - \$missingName\$

- Welding construction with threaded holes for floor fixation
- without height adjustment
- without Spacer ring

Safety control modules



SRB200ZHX1

- Monitoring two-hand control panels to EN 574 III A
- 2 safety contacts, STOP 0



SRB201ZHX3

- Monitoring two-hand control panels to EN 574 III C
- 2 safety contacts, STOP 0
- 1 Signalling output

SRB201ZH

- Monitoring two-hand control panels to EN 574 III C
- 2 safety contacts, STOP 0
- 1 Signalling output



K.A. Schmersal GmbH & Co. KG, Möddinghofe 30, D-42279 Wuppertal

The data and values have been checked thoroughly. Technical modifications and errors excepted.

Generiert am 13.02.2019 - 14:54:01h Kasbase 3.3.0.F.64I