

## Datasheet - UV10H 431Y



Position switch / medium heavy Position switch / Universal range U - Metal enclosure / U 431 / U 431 Rod lever 10H



- Metal enclosure
- 1 Contact
- 62 mm x 58 mm x 50 mm ( basic component)
- Switching points and contact function adjustable
- 1 Cable entry M 20 x 1.5
- Actuator head can be repositioned in steps 4 x 90°
- Continuous adjustment of lever position 360°
- Lever can be transposed by 180°
- Epoxy resin rod

(Minor differences between the printed image and the original product may exist!)

### Ordering details

Product type description	UV10H 431Y
Article number	101060488
EAN Code	
eCl@ss	27-27-06-01

### Approval

Approval



### Global Properties

Permanent light	U 431 Stabschwenkhebel 10H
Standards	EN 60947-5-1
Compliance with the Directives (Y/N) 	Yes
Suitable for safety functions (Y/N)	No
Standard housing (Y/N)	No
Materials	
- Material of the housings	light alloy die-casting
- Material of the rod	Epoxy resin
- Material of the contacts	Silver
Housing coating	painted

Weight	465
Slide form	

## Mechanical data

---

Design of electrical connection	Screw connection
Cable section	
- Min. Cable section	1.5
- Max. Cable section	2.5
AWG-Number	13
Active principle	mechanical
Mechanical life	10.000.000 operations
Contact life	2.000.000 operations, at 6 A / 400 V, $\cos \varphi = 0,4$
notice	All indications about the cable section are including the conductor ferrules.
Design of actuating element	Rod lever
Contact opening	2 x 1.5
Actuating speed with vertical actuating angle to switch axis	
- Min. Actuating speed	1
- Max. Actuating speed	3
- Actuating angle from left of switch axis	30
- Actuating angle from right of switch axis	30

## Ambient conditions

---

Ambient temperature	
- Min. environmental temperature	-20
- Max. environmental temperature	+60
Protection class	IP65 to IEC/EN 60529

## Electrical data

---

Design of control element	Opener (NC)
Switching principle	Creep circuit element
Number of shutters	0
Number of openers	1
Rated insulation voltage $U_i$	500 V
Thermal test current $I_{the}$	16 A
Max. fuse rating	16 A gG D-fuse

## Dimensions

---

Dimensions of the sensor	
- Width of sensor	62
- Height of sensor	258
- Length of sensor	50
Staff diameter	6

## notice

---

Type of contact and switching points can be factory set to order.

## Indication legend

---





see drawing: Operating principle

Contact function, i. e. NC or NO contact, and switching points can be adjusted using a screwdriver

## Diagram





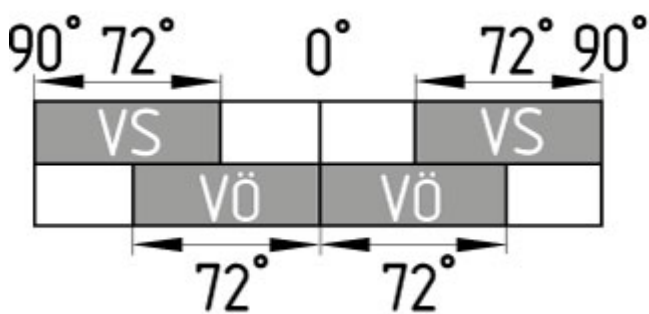

Note Diagram

-  positive break NC contact
-  active
-  no active
-  Normally-open contact
-  Normally-closed contact

## Switch travel diagram



Notes Switch travel diagram

-  Contact closed
-  Contact open
-  Setting range
-  Break point
-  Positive opening sequence/- angle
- VS** adjustable range of NO contact
- VÖ** adjustable range of NC contact
- N** after travel

## Ordering suffix

The applicable ordering suffix is added at the end of the part number of the safety switch.

Order example: UV10H 431Y- 1272

...- 1272

Version for low temperatures to -30°C

## Ordering code

U(1) 431Y-(2)-(3)

(1)

<b>S</b>	Plunger S
<b>K</b>	Offset roller lever K
<b>8H</b>	Roller lever 8H
<b>H</b>	Roller lever H
<b>3H</b>	Roller lever 3H
<b>7H</b>	Roller lever 7H

<b>4H</b>	Spring rod lever on shaft 4H
<b>9H</b>	Rod lever 9H
<b>10H</b>	Rod lever 10H
<b>2H</b>	Leaf-spring lever 2H
<b>6H</b>	Leaf-spring lever 6H
<b>(2)</b>	
<i>without</i>	1 Opener (NC)
<b>1S</b>	1 Normally open contact (NO)
<b>(3)</b>	
<b>1272</b>	Version for low temperatures to -30°C

## Documents

---

### **Operating instructions and Declaration of conformity (nl)** 95 kB, 20.07.2018

Code: mrlk\_posi-allgemein\_nl

### **Operating instructions and Declaration of conformity (ru)** 133 kB, 09.07.2018

Code: mrlk\_posi-allgemein\_ru

### **Operating instructions and Declaration of conformity (es)** 88 kB, 09.07.2018

Code: mrlk\_posi-allgemein\_es

### **Operating instructions and Declaration of conformity (en)** 86 kB, 09.07.2018

Code: mrlk\_posi-allgemein\_en

### **Operating instructions and Declaration of conformity (cn)** 138 kB, 09.07.2018

Code: mrlk\_posi-allgemein\_cn

### **Operating instructions and Declaration of conformity (it)** 86 kB, 09.07.2018

Code: mrlk\_posi-allgemein\_it

### **Operating instructions and Declaration of conformity (jp)** 285 kB, 09.07.2018

Code: mrlk\_posi-allgemein\_jp

### **Operating instructions and Declaration of conformity (pl)** 118 kB, 09.07.2018

Code: mrlk\_posi-allgemein\_pl

### **Operating instructions and Declaration of conformity (fr)** 85 kB, 09.07.2018

Code: mrlk\_posi-allgemein\_fr

### **Operating instructions and Declaration of conformity (pt)** 86 kB, 09.07.2018

Code: mrlk\_posi-allgemein\_pt

### **Operating instructions and Declaration of conformity (de)** 88 kB, 09.07.2018

Code: mrlk\_posi-allgemein\_de

### **Operating instructions (pl)** 369 kB, 30.11.2018

Code: mrlk\_u431-u434\_pl

### **Operating instructions (en)** 352 kB, 06.08.2018

Code: mrlk\_u431-u434\_en

### **Operating instructions (es)** 350 kB, 08.08.2018

Code: mrlk\_u431-u434\_es

**Operating instructions** (nl) 365 kB, 12.11.2018

Code: mrlk\_u431-u434\_nl

**Mounting and wiring instructions** (de, en, fr) 209 kB, 17.03.2008

Code: m\_43sp01

**Operating instructions** (de) 348 kB, 06.08.2018

Code: mrlk\_u431-u434\_de

**Operating instructions** (pt) 350 kB, 23.08.2018

Code: mrlk\_u431-u434\_pt

**Declaration of conformity** (en) 158 kB, 07.11.2017

Code: konfi\_mrl\_u43\_en

**Declaration of conformity** (de) 128 kB, 07.11.2017

Code: konfi\_mrl\_u43\_de

**EAC certification** (ru) 388 kB, 20.01.2016

Code: q\_1527p17\_ru

## Images

---

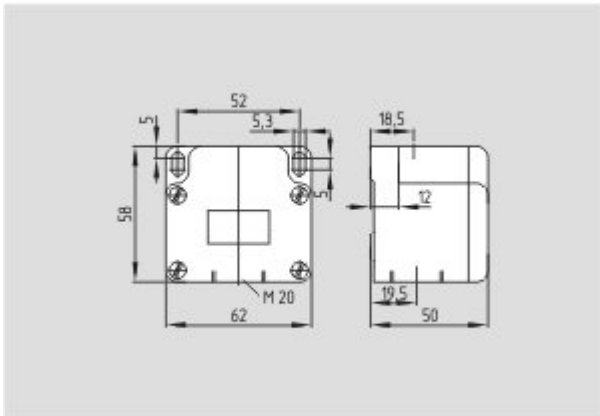

Dimensional drawing (basic component)

---

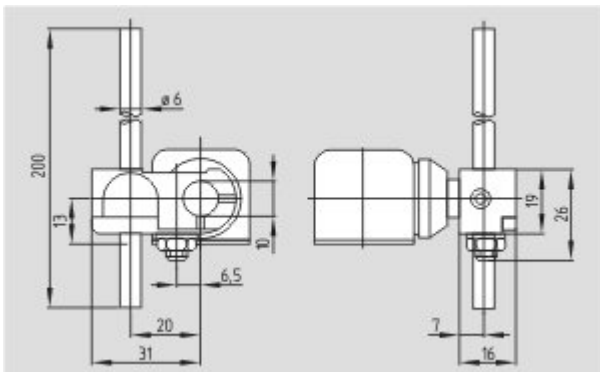

Dimensional drawing (miscellaneous)

---

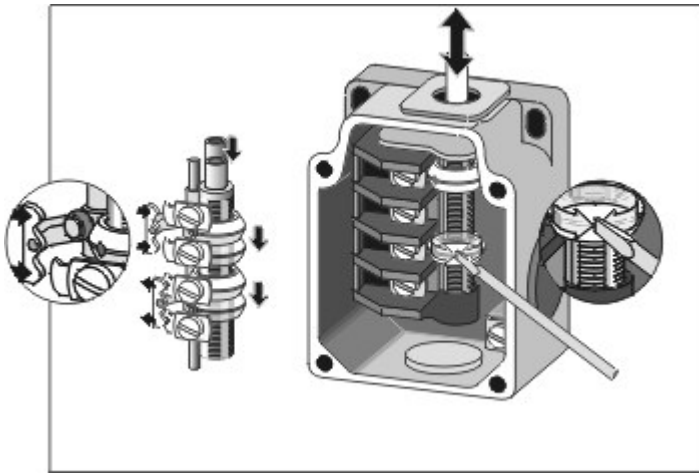

Operating principle

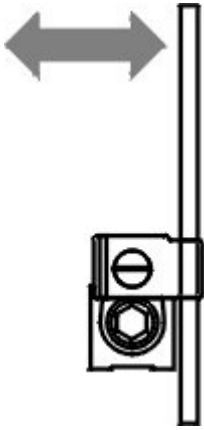

Operating principle