

Datasheet - T4V7H 335-20z

Position switch / 335 Metal enclosure - EN 50041 with Actuator / 335 Roller lever 7H



- Metal enclosure
- Wide range of alternative actuators
- Good resistance to oil and petroleum spirit
- 40,5 mm x 76 mm x 38 mm
- Actuator heads can be repositioned by 4 x 90°
- **only for positioning tasks**
- 1 Cable entry M 20 x 1.5
- Design to EN 50041

(Minor differences between the printed image and the original product may exist!)

Ordering details

| | |
|--------------------------|---------------|
| Product type description | T4V7H 335-20Z |
| Article number | 101082568 |
| EAN Code | 4030661064246 |
| eCl@ss | 27-27-26-01 |

Approval

Approval

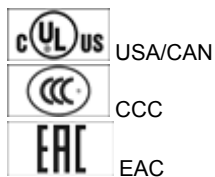

Classification

| | |
|--------------|--|
| Standards | EN ISO 13849-1 |
| Mission time | 20 Years |
| notice | $MTTF_d = \frac{B_{10d}}{0,1 \times n_{op}}$ $n_{op} = \frac{d_{op} \times h_{op} \times 3600 \text{ s/h}}{t_{cycle}}$ |

Global Properties

| | |
|-----------------|-----------------------------|
| Permanent light | T 335 Rollenschwenkhebel 7H |
|-----------------|-----------------------------|

| | |
|--|---------------------------|
| Standards | EN 60947-5-1, BG-GS-ET-15 |
| Compliance with the Directives (Y/N)  | Yes |
| Suitable for safety functions (Y/N) | No |
| Materials | |
| - Material of the housings | Aluminium |
| - Lever material | Metal film |
| - Roller material | Plastic |
| - Material of the contacts | Silver |
| Housing coating | painted |
| Housing construction form | Norm construction design |
| Weight | 265 |

Mechanical data

| | |
|---|---|
| Design of electrical connection | Screw connection |
| Cable section | |
| - Min. Cable section | 0,75 |
| - Max. Cable section | 2.5 |
| Mechanical life | 30.000.000 operations |
| Switching frequency | max. 5000 /h |
| notice | All indications about the cable section are including the conductor ferrules. |
| Design of actuating element | Roller lever |
| actuating torque | min. 31 Ncm |
| Bounce duration | < 2 |
| Switchover time | in accordance with actuating speed |
| Actuating speed with actuating angle 30° to switch axis | |
| - Min. Actuating speed | |
| - Max. Actuating speed | 2.5 m/s |

Ambient conditions

| | |
|----------------------------------|--------|
| Ambient temperature | |
| - Min. environmental temperature | -30 °C |
| - Max. environmental temperature | +80 °C |
| Protection class | IP67 |

Electrical data

| | |
|---|--|
| Design of control element | Normally open contact (NO) |
| Switching principle | Slow action |
| Number of auxiliary contacts | 2 |
| Number of safety contacts | 0 |
| Rated impulse withstand voltage U_{imp} | 6 kV |
| Rated insulation voltage U_i | 500 V |
| Thermal test current I_{the} | 10 A |
| Utilisation category | AC-15: 230 V / 4 A, DC-13: 24 V / 4 A |
| Required rated short-circuit current | 1000 A |
| Max. fuse rating | 6 A gG D-fuse |

ATEX

| | |
|---|------|
| Explosion protection categories for gases | None |
| Explosion protected category for dusts | None |

Dimensions

Dimensions of the sensor

| | |
|--------------------|----------|
| - Width of sensor | 40.5 mm |
| - Height of sensor | 183 mm |
| - Length of sensor | 57.25 mm |



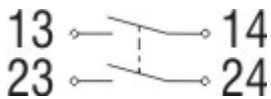

notice

Switch with 2 NO contacts are not for security tasks

Diagram





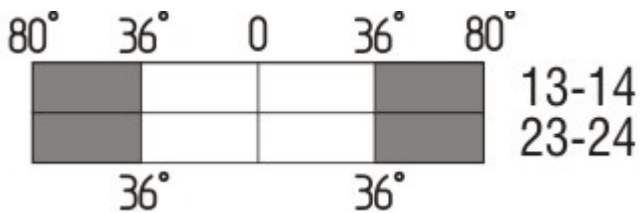

Note Diagram

-  positive break NC contact
-  active
-  no active
-  Normally-open contact
-  Normally-closed contact

Switch travel diagram



Notes Switch travel diagram

-  Contact closed
-  Contact open
-  Setting range
-  Break point
-  Positive opening sequence/- angle
- VS** adjustable range of NO contact
- VÖ** adjustable range of NC contact
- N** after travel

Ordering suffix

The applicable ordering suffix is added at the end of the part number of the safety switch.

Order example: T4V7H 335-20z-**1637**

....**1637**

0,3 µm gold-plated contacts

....**NPT**

Cable entry NPT 1/2"



M12 connector with A-coding
 Rated impulse withstand voltage U_{imp} : 0,8 kV
 Rated insulation voltage U_i : 50 V
 Operating current I_e : AC-15: 50 V / 4 A
 Caution! The versions with connector may only be used in PELV circuits to EN 60204-1.

...ST

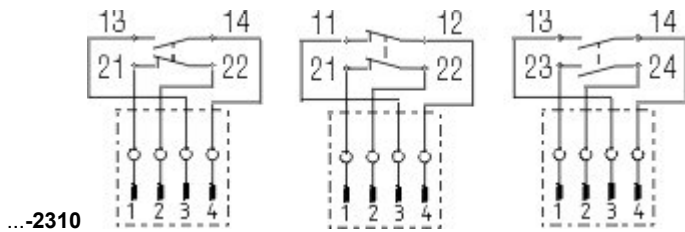

M12 connector with B-coding
 Rated impulse withstand voltage U_{imp} : 0,8 kV
 Rated insulation voltage U_i : 50 V
 Operating current I_e : AC-15: 50 V / 4 A
 Caution! The versions with connector may only be used in PELV circuits to EN 60204-1.

...-2310

Ordering code

(1)(2) 3(3)5-(4)Z(5)-(6)-(7)-(8)-(9)

(1)

Z Snap action
 T Slow action

(2)

S Plunger S
 R Roller plunger R
 H Roller lever H
 10H Rod lever 10H
 7H Roller lever 7H
 1K Offset roller lever 1K
 3K Angle roller lever 3K

(3)

3 slim design
 5 large design

(4)

11 1 Normally open contact (NO) / 1 Opener (NC)
 02 2 Opener (NC)
 20 2 Normally open contact (NO) (*Switch with 2 NO contacts are not for security tasks*)
 01/01 1 Opener (NC) left / 1 Opener (NC) right
 12 1 Normally open contact (NO) / 2 Opener (NC)
 03 3 Opener (NC)

(5)

H Slow action with staggered contacts
 UE Slow action with overlapping contacts

(6)

G24 with LED

(7)

without Cable entry M20
 NPT cable entry NPT 1/2"
 ST M12 connector with A-coding (*Caution! The versions with connector may only be used in PELV circuits to EN 60204-1.*)
 ST-2310 M12 connector with B-coding (*Caution! The versions with connector may only be used in PELV circuits to EN 60204-1.*)

(8)

2138 Roller lever 7H for Position switches with safety function

(9)

1637 gold-plated contacts

Documents

Operating instructions and Declaration of conformity (de) 157 kB, 18.06.2018

Code: mrlk_zt332-335-336-355_de

Operating instructions and Declaration of conformity (nl) 162 kB, 27.06.2018

Code: mrlk_zt332-335-336-355_nl

Operating instructions and Declaration of conformity (it) 162 kB, 27.06.2018

Code: mrlk_zt332-335-336-355_it

Operating instructions and Declaration of conformity (pt) 163 kB, 27.06.2018

Code: mrlk_zt332-335-336-355_pt

Operating instructions and Declaration of conformity (pl) 198 kB, 27.06.2018

Code: mrlk_zt332-335-336-355_pl

Operating instructions and Declaration of conformity (en) 160 kB, 18.06.2018

Code: mrlk_zt332-335-336-355_en

Operating instructions and Declaration of conformity (fr) 164 kB, 27.06.2018

Code: mrlk_zt332-335-336-355_fr

Declaration of conformity (es) 91 kB, 18.06.2018

Code: KAS_konfi_nsr_zt2xx-3xx_es

Declaration of conformity (pl) 130 kB, 18.06.2018

Code: KAS_konfi_nsr_zt2xx-3xx_pl

Declaration of conformity (it) 89 kB, 18.06.2018

Code: KAS_konfi_nsr_zt2xx-3xx_it

Declaration of conformity (pt) 90 kB, 18.06.2018

Code: KAS_konfi_nsr_zt2xx-3xx_pt

Declaration of conformity (fr) 89 kB, 18.06.2018

Code: KAS_konfi_nsr_zt2xx-3xx_fr

Declaration of conformity (de) 581 kB, 07.06.2018

Code: KAS_konfi_nsr_zt2xx-3xx_de

Declaration of conformity (en) 579 kB, 07.06.2018

Code: KAS_konfi_nsr_zt2xx-3xx_en

Declaration of conformity (nl) 89 kB, 18.06.2018

Code: KAS_konfi_nsr_zt2xx-3xx_nl

CCC certification (en) 187 kB, 03.08.2015

Code: q_347p02

CCC certification (cn) 166 kB, 03.08.2015

Code: q_347p03

EAC certification (ru) 844 kB, 05.10.2015

Code: q_6037p17_ru

Images

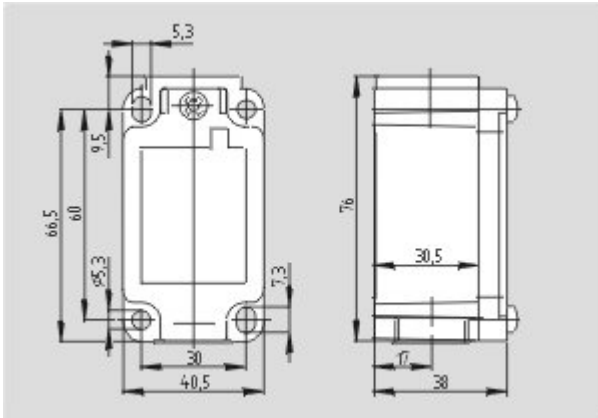

Dimensional drawing (basic component)

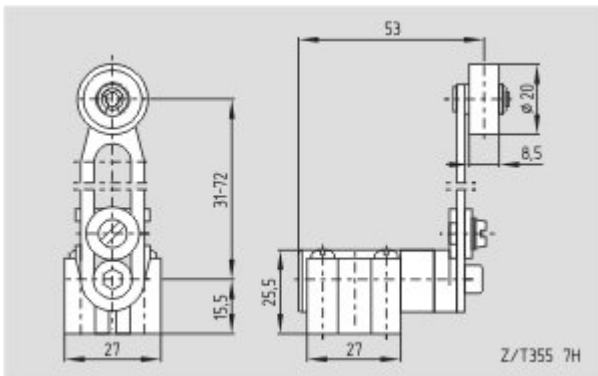

Dimensional drawing (actuator)

K.A. Schmersal GmbH & Co. KG, Möddinghofe 30, D-42279 Wuppertal

The data and values have been checked thoroughly. Technical modifications and errors excepted.

Generiert am 13.02.2019 - 13:22:56h Kasbase 3.3.0.F.64I