

## Datasheet - TV7H 236-11z-2138



Position switch / 236 Thermoplastic enclosure - EN 50047 with Actuator / 236 Roller lever  
7H-2138



- Thermoplastic enclosure
- Good resistance to oil and petroleum spirit
- Wide range of alternative actuators
- 30 mm x 58,5 mm x 30 mm
- 1 Cable entry M 20 x 1.5
- Double-insulated
- Mounting details to EN 50047
- Actuator heads can be repositioned by 4 x 90°
- Lever angle adjustable in 10° steps

(Minor differences between the printed image and the original product may exist!)

### Ordering details

Product type description	TV7H 236-11Z-2138
Article number	101122631
EAN Code	4030661069333
eCl@ss	27-27-26-01

### Approval

Approval

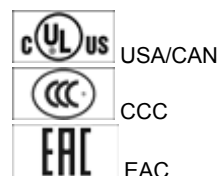

### Classification

Standards	ISO 13849-1
B10d Normally-closed contact (NC)	20.000.000
Mission time	20 Years
notice	$MTTF_d = \frac{B_{10d}}{0,1 \times n_{op}}$ $n_{op} = \frac{d_{op} \times h_{op} \times 3600 \text{ s/h}}{t_{cycle}}$

## Global Properties

---

Permanent light	T 236 Rollenschwenkhebel 7H-2138
Standards	IEC 60947-5-1, ISO 13849-1, BG-GS-ET-15
Compliance with the Directives (Y/N) 	Yes
Suitable for safety functions (Y/N)	Yes
Materials	
- Material of the housings	Plastic, glass-fibre reinforced thermoplastic, self-extinguishing
- Lever material	Metal film
- Roller material	Plastic
- Material of the contacts	Silver
Housing coating	None
Housing construction form	Norm construction design
Weight	95

## Mechanical data

---

Design of electrical connection	Screw connection
Cable section	
- Min. Cable section	0,75
- Max. Cable section	2.5
Mechanical life	20.000.000 operations
Switching frequency	max. 5000 /h
notice	All indications about the cable section are including the conductor ferrules.
Design of actuating element	Roller lever
actuating torque	min. 15 Ncm
Bounce duration	in accordance with actuating speed
Switchover time	in accordance with actuating speed
Positive break torque	18.5 Ncm
Actuating speed with actuating angle 30° to switch axis	
- Min. Actuating speed	1440 mm/min
- Max. Actuating speed	1 m/s

## Ambient conditions

---

Ambient temperature	
- Min. environmental temperature	-30 °C
- Max. environmental temperature	+80 °C
Protection class	IP67

## Electrical data

---

Design of control element	Normally open contact (NO), Opener (NC)
Switching principle	Creep circuit element
- positive break NC contact 	
Number of auxiliary contacts	1
Number of safety contacts	1
Rated impulse withstand voltage $U_{imp}$	6 kV
Rated insulation voltage $U_i$	500 V
Thermal test current $I_{the}$	10 A
Utilisation category	AC-15: 230 V / 4 A, DC-13: 24 V / 1 A
Required rated short-circuit current	1000 A
Max. fuse rating	6 A gG D-fuse

## Dimensions

Dimensions of the sensor

- Width of sensor	30 mm
- Height of sensor	158.5 mm
- Length of sensor	49 mm

## Diagram



Note Diagram

- positive break NC contact
- active
- no active
- Normally-open contact
- Normally-closed contact

## Switch travel diagram

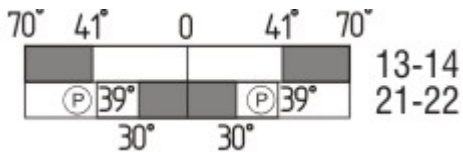

Notes Switch travel diagram

- Contact closed
- Contact open
- Setting range
- Break point
- Positive opening sequence/- angle
- VS** adjustable range of NO contact
- VÖ** adjustable range of NC contact
- N** after travel

## Ordering suffix

The applicable ordering suffix is added at the end of the part number of the safety switch.

Order example: TV7H 236-11z-2138-**1637**

....- <b>1637</b>	0,3 µm gold-plated contacts
....- <b>ID</b>	IDC method of termination
....- <b>NPT</b>	Cable entry NPT 1/2"
....- <b>1297</b>	Enclosure with transverse slotted holes
....- <b>Z</b>	Actuator head gasket

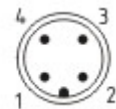
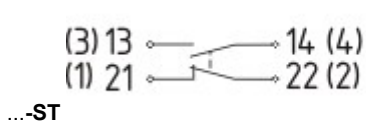

M12 connector with A-coding  
 Rated impulse withstand voltage  $U_{imp}$ : 4 kV  
 Rated insulation voltage  $U_i$ : 250 V  
 Rated operating voltage  $U_e$ : 230 V  
 Operating current  $I_e$ : 4 A

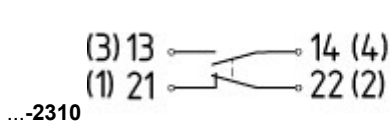

M12 connector with B-coding  
 Rated impulse withstand voltage  $U_{imp}$ : 4 kV  
 Rated insulation voltage  $U_i$ : 250 V  
 Rated operating voltage  $U_e$ : 230 V  
 Operating current  $I_e$ : 4 A

## Ordering code

(1)(2) 2(3)6-(4)Z(5)-(6)-(7)-(8)-(9)

(1)

Z

T

Snap action

Slow action

(2)

S

Plunger S

R

Roller plunger R

4S

Plunger 4S

4R

Roller plunger 4R

1R

Offset roller lever 1R

K

Offset roller lever K

3K

Angle roller lever 3K

4K

Angle roller lever 4K

K4

Angle roller lever K4

1H

Roller lever 1H

7H

Roller lever 7H

10H

Rod lever 10H

12H

Roller lever 12H

14H

Roller lever 14H

AF

Spring rod lever AF

(3)

3

slim design

5

large design

(4)

02

2 Opener (NC)

11

1 Normally open contact (NO) / 1 Opener (NC)

20

2 Normally open contact (NO), (Switch with 2 NO contacts are not for security tasks)

(5)

H

Slow action with staggered contacts

UE

Slow action with overlapping contacts

(6)

without

Cable entry M20

ID

IDC method of termination

NPT

cable entry NPT 1/2"

ST

M12 connector with A-coding

ST-2310

M12 connector with B-coding

(7)

1297	Enclosure with transverse slotted holes
(8)	
2138	Roller lever 7H for Position switches with safety function
(9)	
1637	gold-plated contacts

## Documents

---

**Operating instructions and Declaration of conformity** (en) 160 kB, 15.06.2018

Code: mrlk\_zt235\_236\_en

**Operating instructions and Declaration of conformity** (es) 161 kB, 21.06.2018

Code: mrlk\_ZT235\_236\_es

**Operating instructions and Declaration of conformity** (de) 160 kB, 15.06.2018

Code: mrlk\_ZT235\_236\_de

**Operating instructions and Declaration of conformity** (pl) 198 kB, 27.06.2018

Code: mrlk\_ZT235\_236\_pl

**Operating instructions and Declaration of conformity** (nl) 162 kB, 15.06.2018

Code: mrlk\_ZT235\_236\_nl

**Operating instructions and Declaration of conformity** (pt) 163 kB, 27.06.2018

Code: mrlk\_ZT235\_236\_pt

**Operating instructions and Declaration of conformity** (it) 162 kB, 15.06.2018

Code: mrlk\_ZT235\_236\_it

**Operating instructions and Declaration of conformity** (fr) 164 kB, 15.06.2018

Code: mrlk\_ZT235\_236\_fr

**Operating instructions and Declaration of conformity** (cs) 194 kB, 25.01.2019

Code: mrlk\_ZT235\_236\_cs

**Declaration of conformity** (es) 91 kB, 18.06.2018

Code: KAS\_konfi\_nsr\_zt2xx-3xx\_es

**Declaration of conformity** (pl) 130 kB, 18.06.2018

Code: KAS\_konfi\_nsr\_zt2xx-3xx\_pl

**Declaration of conformity** (it) 89 kB, 18.06.2018

Code: KAS\_konfi\_nsr\_zt2xx-3xx\_it

**Declaration of conformity** (pt) 90 kB, 18.06.2018

Code: KAS\_konfi\_nsr\_zt2xx-3xx\_pt

**Declaration of conformity** (fr) 89 kB, 18.06.2018

Code: KAS\_konfi\_nsr\_zt2xx-3xx\_fr

**Declaration of conformity** (de) 581 kB, 07.06.2018

Code: KAS\_konfi\_nsr\_zt2xx-3xx\_de

**Declaration of conformity** (en) 579 kB, 07.06.2018

Code: KAS\_konfi\_nsr\_zt2xx-3xx\_en

**Declaration of conformity** (nl) 89 kB, 18.06.2018

Code: KAS\_konfi\_nsr\_zt2xx-3xx\_nl

**CCC certification** (cn) 4 MB, 11.04.2018

Code: q\_235p02

**CCC certification** (en) 4 MB, 27.10.2017

Code: q\_235p01

**EAC certification** (ru) 844 kB, 05.10.2015

Code: q\_6037p17\_ru

## Images

---

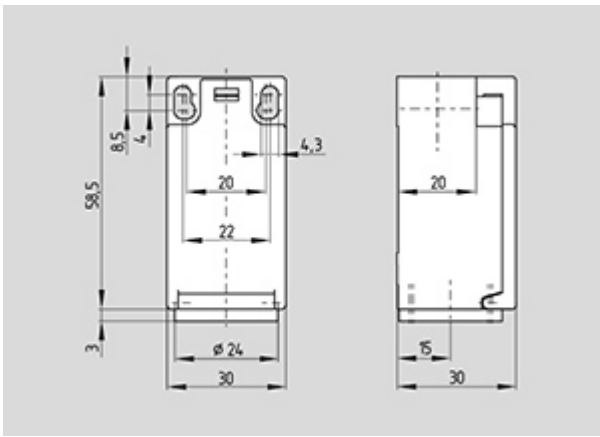

Dimensional drawing (basic component)

---

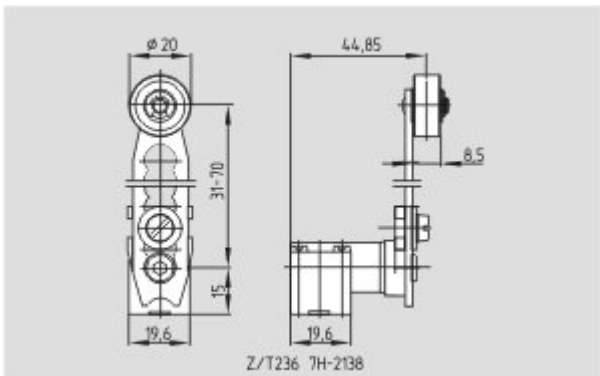

Dimensional drawing (actuator)

---

K.A. Schmersal GmbH & Co. KG, Mödinghofe 30, D-42279 Wuppertal

The data and values have been checked thoroughly. Technical modifications and errors excepted.

Generiert am 13.02.2019 - 13:20:27h Kasbase 3.3.0.F.64I