

## Datasheet - T4VH 335-02z

Position switch / 335 Metal enclosure - EN 50041 with Actuator / 335 Roller lever H



Preferred typ



- Metal enclosure
- Wide range of alternative actuators
- Good resistance to oil and petroleum spirit
- 40,5 mm x 76 mm x 38 mm
- Actuator heads can be repositioned by 4 x 90°
- 1 Cable entry M 20 x 1.5
- Design to EN 50041

(Minor differences between the printed image and the original product may exist!)

### Ordering details

Product type description	T4VH 335-02Z
Article number	101168107
EAN Code	4030661220673
eCl@ss	27-27-26-01

### Approval

Approval

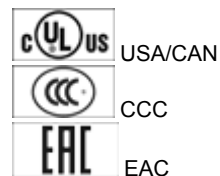

### Classification

Standards	EN ISO 13849-1
B10d Normally-closed contact (NC)	20.000.000
Mission time	20 Years
notice	$MTTF_d = \frac{B_{10d}}{0,1 \times n_{op}}$ $n_{op} = \frac{d_{op} \times h_{cp} \times 3600 \text{ s/h}}{t_{cycle}}$

### Global Properties

Permanent light	T 335 Rollenschwenkhebel H
Standards	EN 60947-5-1, BG-GS-ET-15
Compliance with the Directives (Y/N) 	Yes
Suitable for safety functions (Y/N)	Yes
Actuator type	A to EN 50041
Materials	
- Material of the housings	Aluminium
- Lever material	Metal film
- Roller material	Plastic
- Material of the contacts	Silver
Housing coating	painted
Housing construction form	Norm construction design
Weight	260

### Mechanical data

Design of electrical connection	Screw connection
Cable section	
- Min. Cable section	0,75
- Max. Cable section	2.5
Mechanical life	30.000.000 operations
Switching frequency	max. 5000 /h
notice	All indications about the cable section are including the conductor ferrules.
Design of actuating element	Roller lever
actuating torque	min. 31 Ncm
Bounce duration	< 2
Switchover time	in accordance with actuating speed
Actuating speed with actuating angle 30° to switch axis	
- Min. Actuating speed	
- Max. Actuating speed	2.5 m/s

### Ambient conditions

Ambient temperature	
- Min. environmental temperature	-30 °C
- Max. environmental temperature	+80 °C
Protection class	IP67

### Electrical data

Design of control element	Opener (NC)
Switching principle	Slow action
- positive break NC contact 	
Number of auxiliary contacts	0
Number of safety contacts	2
Rated impulse withstand voltage $U_{imp}$	6 kV
Rated insulation voltage $U_i$	500 V
Thermal test current $I_{the}$	10 A
Utilisation category	AC-15: 230 V / 4 A, DC-13: 24 V / 4 A
Required rated short-circuit current	1000 A
Max. fuse rating	6 A gG D-fuse

## ATEX

Explosion protection categories for gases	None
Explosion protected category for dusts	None

## Dimensions

Dimensions of the sensor	
- Width of sensor	40.5 mm
- Height of sensor	134 mm
- Length of sensor	60.55 mm

## Diagram

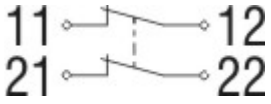

Note Diagram

- positive break NC contact
- active
- no active
- Normally-open contact
- Normally-closed contact

## Switch travel diagram

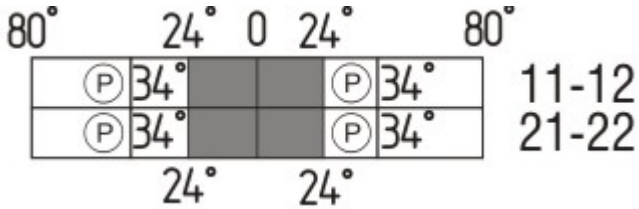

Notes Switch travel diagram

- Contact closed
- Contact open
- Setting range
- Break point
- Positive opening sequence/- angle
- VS** adjustable range of NO contact
- VÖ** adjustable range of NC contact
- N** after travel

## Ordering suffix

The applicable ordering suffix is added at the end of the part number of the safety switch.

Order example: T4VH 335-02z-**1637**

...-**1637** 0,3 µm gold-plated contacts

...-**NPT** Cable entry NPT 1/2"



...-ST

M12 connector with A-coding  
 Rated impulse withstand voltage  $U_{imp}$ : 0,8 kV  
 Rated insulation voltage  $U_i$ : 50 V  
 Operating current  $I_e$ : AC-15: 50 V / 4 A  
 Caution! The versions with connector may only be used in PELV circuits to EN 60204-1.

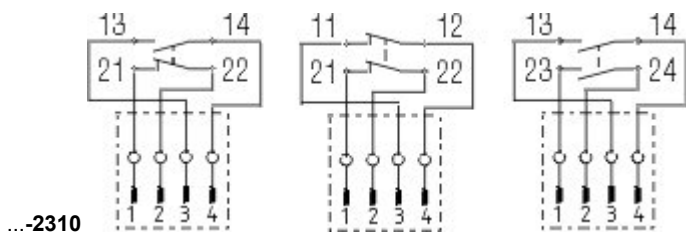

...-2310

M12 connector with B-coding  
 Rated impulse withstand voltage  $U_{imp}$ : 0,8 kV  
 Rated insulation voltage  $U_i$ : 50 V  
 Operating current  $I_e$ : AC-15: 50 V / 4 A  
 Caution! The versions with connector may only be used in PELV circuits to EN 60204-1.

...-RMS

Available with metal roller

...-1H

Roller material : Plastic  
 Durchmesser : 25 mm

## Ordering code

(1)(2) 3(3)5-(4)Z(5)-(6)-(7)-(8)-(9)

(1)

Z

Snap action

T

Slow action

(2)

S

Plunger S

R

Roller plunger R

H

Roller lever H

10H

Rod lever 10H

7H

Roller lever 7H

1K

Offset roller lever 1K

3K

Angle roller lever 3K

(3)

3

slim design

5

large design

(4)

11

1 Normally open contact (NO) / 1 Opener (NC)

02

2 Opener (NC)

20

2 Normally open contact (NO) (Switch with 2 NO contacts are not for security tasks)

01/01

1 Opener (NC) left / 1 Opener (NC) right

12

1 Normally open contact (NO) / 2 Opener (NC)

03

3 Opener (NC)

(5)

H

Slow action with staggered contacts

UE

Slow action with overlapping contacts

(6)

G24

with LED

(7)

<i>without</i>	Cable entry M20
<b>NPT</b>	cable entry NPT 1/2"
<b>ST</b>	M12 connector with A-coding ( <i>Caution! The versions with connector may only be used in PELV circuits to EN 60204-1.</i> )
<b>ST-2310</b>	M12 connector with B-coding ( <i>Caution! The versions with connector may only be used in PELV circuits to EN 60204-1.</i> )
<b>(8)</b>	
<b>2138</b>	Roller lever 7H for Position switches with safety function
<b>(9)</b>	
<b>1637</b>	gold-plated contacts

## Documents

---

### Operating instructions and Declaration of conformity (de) 157 kB, 18.06.2018

Code: mrlk\_zt332-335-336-355\_de

### Operating instructions and Declaration of conformity (nl) 162 kB, 27.06.2018

Code: mrlk\_zt332-335-336-355\_nl

### Operating instructions and Declaration of conformity (it) 162 kB, 27.06.2018

Code: mrlk\_zt332-335-336-355\_it

### Operating instructions and Declaration of conformity (pt) 163 kB, 27.06.2018

Code: mrlk\_zt332-335-336-355\_pt

### Operating instructions and Declaration of conformity (pl) 198 kB, 27.06.2018

Code: mrlk\_zt332-335-336-355\_pl

### Operating instructions and Declaration of conformity (en) 160 kB, 18.06.2018

Code: mrlk\_zt332-335-336-355\_en

### Operating instructions and Declaration of conformity (fr) 164 kB, 27.06.2018

Code: mrlk\_zt332-335-336-355\_fr

### Declaration of conformity (es) 91 kB, 18.06.2018

Code: KAS\_konfi\_nsr\_zt2xx-3xx\_es

### Declaration of conformity (pl) 130 kB, 18.06.2018

Code: KAS\_konfi\_nsr\_zt2xx-3xx\_pl

### Declaration of conformity (it) 89 kB, 18.06.2018

Code: KAS\_konfi\_nsr\_zt2xx-3xx\_it

### Declaration of conformity (pt) 90 kB, 18.06.2018

Code: KAS\_konfi\_nsr\_zt2xx-3xx\_pt

### Declaration of conformity (fr) 89 kB, 18.06.2018

Code: KAS\_konfi\_nsr\_zt2xx-3xx\_fr

### Declaration of conformity (de) 581 kB, 07.06.2018

Code: KAS\_konfi\_nsr\_zt2xx-3xx\_de

### Declaration of conformity (en) 579 kB, 07.06.2018

Code: KAS\_konfi\_nsr\_zt2xx-3xx\_en

**Declaration of conformity** (nl) 89 kB, 18.06.2018

Code: KAS\_konfi\_nsr\_zt2xx-3xx\_nl

**CCC certification** (en) 187 kB, 03.08.2015

Code: q\_347p02

**CCC certification** (cn) 166 kB, 03.08.2015

Code: q\_347p03

**EAC certification** (ru) 844 kB, 05.10.2015

Code: q\_6037p17\_ru

## Images

---

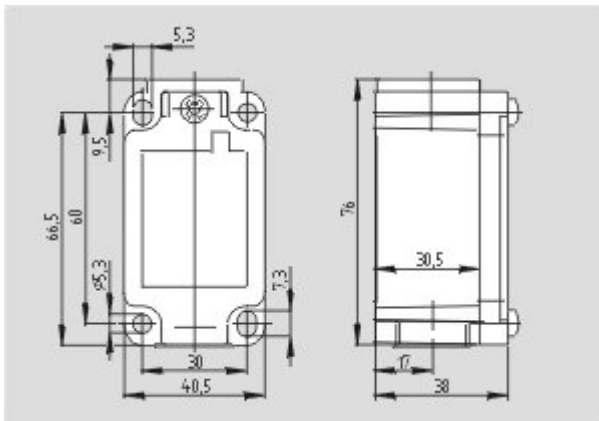

Dimensional drawing (basic component)

---

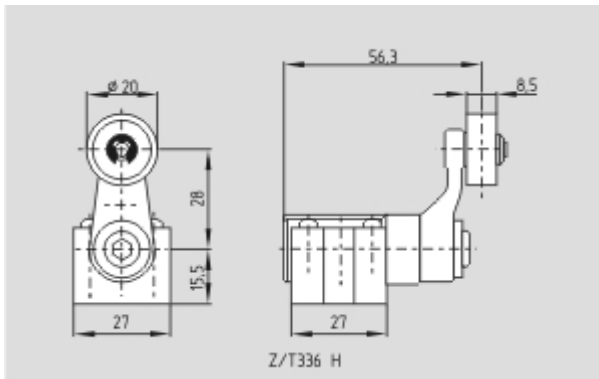

Dimensional drawing (actuator)

---

K.A. Schmersal GmbH & Co. KG, Möddinghofe 30, D-42279 Wuppertal

The data and values have been checked thoroughly. Technical modifications and errors excepted.

Generiert am 13.02.2019 - 13:23:33h Kasbase 3.3.0.F.64I