

Datasheet - MV 471-12Y

Position switch / heavy Position switch / T/M 471 (T 471 / M 471) / 471 Roller lever V



- Metal enclosure
- 4 or 6 Contacts
- 194 mm x 123 mm x 130 mm (basic component)
- 3 cable entries M 25 x 1.5
- Continuous adjustment of lever position 360°

(Minor differences between the printed image and the original product may exist!)

Ordering details

Product type description	MV 471-12Y
Article number	101061025
EAN Code	
eCl@ss	27-27-06-01

Approval

Approval



Global Properties

Permanent light	471 Rollenschwenkhebel V
Standards	EN 60947-5-1
Compliance with the Directives (Y/N) 	Yes
Suitable for safety functions (Y/N)	No
Standard housing (Y/N)	No
Materials	
- Material of the housings	cast iron, galvanized
- Roller material	Plastic
- Material of the contacts	Silver
Housing coating	painted
Weight	
Slide form	Castor

Mechanical data

Design of electrical connection	Screw connection
Cable section	
- Min. Cable section	1.5
- Max. Cable section	4
AWG-Number	11
Active principle	mechanical
Mechanical life	30.000 operations
Switching frequency	1000
notice	All indications about the cable section are including the conductor ferrules.
Design of actuating element	Roller lever
Contact opening	2 x 4
Actuation direction	always 65° right-hand side rotation
Actuating speed with vertical actuating angle to switch axis	
- Min. Actuating speed	0,05
- Max. Actuating speed	3
- Actuating angle from left of switch axis	30
- Actuating angle from right of switch axis	30

Ambient conditions

Ambient temperature	
- Min. environmental temperature	-30
- Max. environmental temperature	+90
Protection class	IP65 to IEC/EN 60529

Electrical data

Design of control element	Normally open contact (NO) / Opener (NC)
- Change-over contact with double break	
- galvanically separated contact bridges	
Switching principle	Snap switch element
Number of shutters	1
Number of openers	2
Rated impulse withstand voltage	6
Rated insulation voltage	500
Thermal test current	25 A
Utilisation category	AC-15: 230 V / 10 A
Max. fuse rating	25 A gG D-fuse



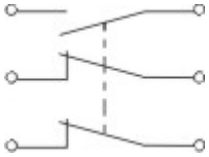

Dimensions

Dimensions of the sensor	
- Width of sensor	194
- Height of sensor	225
- Length of sensor	175
Roller wide	12
Roller diameter	36

Diagram



Note Diagram

-  positive break NC contact
-  active
-  no active
-  Normally-open contact
-  Normally-closed contact

Ordering suffix

The applicable ordering suffix is added at the end of the part number of the safety switch.

Order example: MV 471-12Y- 1

...- 1

...-RMS

Available with metal roller

Documents

Operating instructions and Declaration of conformity (nl) 95 kB, 20.07.2018

Code: mrlk_posi-allgemein_nl

Operating instructions and Declaration of conformity (ru) 133 kB, 09.07.2018

Code: mrlk_posi-allgemein_ru

Operating instructions and Declaration of conformity (es) 88 kB, 09.07.2018

Code: mrlk_posi-allgemein_es

Operating instructions and Declaration of conformity (en) 86 kB, 09.07.2018

Code: mrlk_posi-allgemein_en

Operating instructions and Declaration of conformity (cn) 138 kB, 09.07.2018

Code: mrlk_posi-allgemein_cn

Operating instructions and Declaration of conformity (it) 86 kB, 09.07.2018

Code: mrlk_posi-allgemein_it

Operating instructions and Declaration of conformity (jp) 285 kB, 09.07.2018

Code: mrlk_posi-allgemein_jp

Operating instructions and Declaration of conformity (pl) 118 kB, 09.07.2018

Code: mrlk_posi-allgemein_pl

Operating instructions and Declaration of conformity (fr) 85 kB, 09.07.2018

Code: mrlk_posi-allgemein_fr

Operating instructions and Declaration of conformity (pt) 86 kB, 09.07.2018

Code: mrlk_posi-allgemein_pt

Operating instructions and Declaration of conformity (de) 88 kB, 09.07.2018

Code: mrlk_posi-allgemein_de

Declaration of conformity (en) 86 kB, 19.12.2018

Code: konfi_mrl_tm064_en

Declaration of conformity (de) 88 kB, 04.04.2017

Code: konfi_mrl_tm064_de

CCC certification (en) 1 MB, 24.07.2017

Code: q_355p02

CCC certification (cn) 1 MB, 24.07.2017

Code: q_355p03

EAC certification (ru) 388 kB, 20.01.2016

Code: q_1527p17_ru

Images

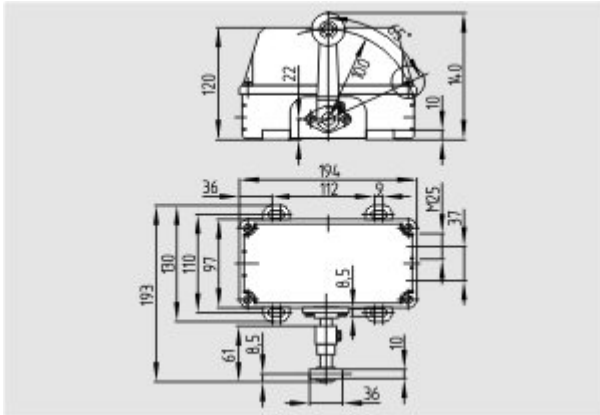

Dimensional drawing (basic component)

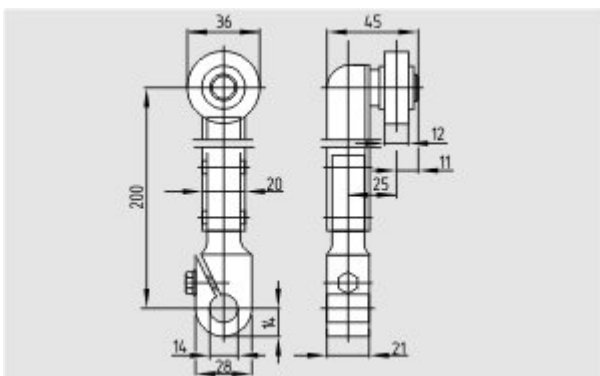

Dimensional drawing (miscellaneous)

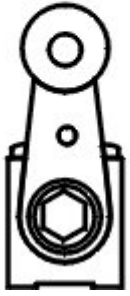

Operating principle

K.A. Schmersal GmbH & Co. KG, Möddinghofe 30, D-42279 Wuppertal
The data and values have been checked thoroughly. Technical modifications and errors excepted.
Generiert am 13.02.2019 - 13:33:04h Kasbase 3.3.0.F.64I