

Datasheet - BPS 300

Safety sensors / BNS 333 / Actuator

 Preferred typ

(Minor differences between the printed image and the original product may exist!)

Ordering details

Product type description	BPS 300
Article number	101113734
EAN Code	4030661022437
eCl@ss	27-27-92-17

Global Properties

Permanent light	Magnet
Materials	
- Material of the housings	Plastic
Weight	30

Dimensions

Dimensions of the actuators	
- Width of the actuator	15
- Diameter of the actuator	30

Included in delivery

tamperproof screws	1 piece
--------------------	---------

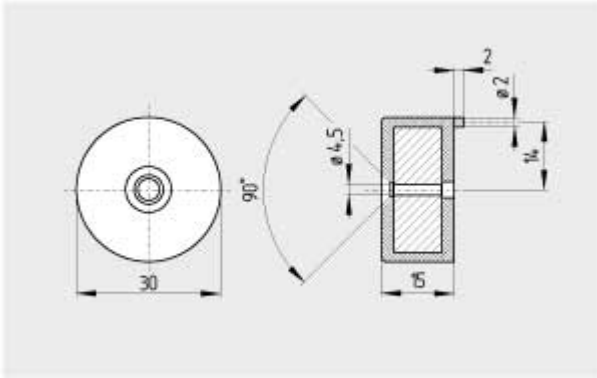

Dimensional drawing (miscellaneous)

K.A. Schmersal GmbH & Co. KG, Möddinghofe 30, D-42279 Wuppertal

The data and values have been checked thoroughly. Technical modifications and errors excepted.

Generiert am 13.02.2019 - 14:25:49h Kasbase 3.3.0.F.64l