

Datasheet - MZM 100 ST-AS REMAP

AS interface safety at work / Safety switchgear / Solenoid interlock / MZM 100 AS



Preferred typ



- Solenoid interlock
- Thermoplastic enclosure
- Integrated AS-Interface
- 40 mm x 179 mm x 40 mm
- Solenoid interlocks (for the protection of man) with innovating and unique operating principle
- Electronic contact-free, coded system
- 3 LEDs to show operating conditions
- Automatic latching
- Sensor technology permits an offset between actuator and interlock of ± 5 mm vertically and ± 3 mm horizontally
- Intelligent diagnosis
- Power to lock
- Guard locking monitored
- Permanent magnet

(Minor differences between the printed image and the original product may exist!)

Ordering details

Product type description	MZM 100 ST-AS REMAP
Article number	101209553
EAN Code	4030661383217
eCl@ss	27-27-26-03

Approval

Approval



Classification

Standards	EN ISO 13849-1, IEC 61508, IEC 60947-5-3
PL	up e
Control category	up 4
PFH	$\leq 5 \times 10^{-9}/h$
SIL	up 3
Mission time	20 Years
Classification	PDF-M

Global Properties

Permanent light	MZM 100 AS
Standards	EN 60947-5-1, IEC 61508, EN 50295, IEC 60947-5-3, EN ISO 13849-1
Compliance with the Directives (Y/N) 	Yes
Suitable for safety functions (Y/N)	Yes
Protection rating	III
Active principle	inductive
Coding	Universal coding
	low
Duty cycle ED	100 %
Materials	
- Material of the housings	Plastic, glass-fibre reinforced thermoplastic
Housing coating	None
Weight	631
Guard locking monitored (Y/N)	Yes
Actuator monitored (Y/N)	No
Response time	< 150 ms
Duration of risk	< 150 ms
Time to readiness	< 4000
Recommended actuator	MZM 100-B1.1

Mechanical data

Design of electrical connection	connector plug M12, 4-pole
Mechanical life	≥ 1.000.000 operations
notice - Mechanical life	operations for guards ≤ 5 kg; actuating speed ≤ 0,5 m/s
restistance to shock	30 g / 11 ms
Resistance to vibration	10 ... 150 HZ, Amplitude 0,35 mm
Latching (Y/N)	Yes
electrically adjustable latching force	30 ... 100
Permanent magnet	30
Clamping force F	500 N

Ambient conditions

Ambient temperature	
- Min. environmental temperature	-25
- Max. environmental temperature	+55
Storage and transport temperature	
- Min. Storage and transport temperature	-25
- Max. Storage and transport temperature	+85
Relative humidity	30... 95
- non-condensing	
- non-icing	
Protection class	IP67 to IEC/EN 60529
Protection rating	III
Air clearances and creepage distances To IEC/EN 60664-1	
- Rated impulse withstand voltage U _{imp}	0,8 kV
- Rated insulation voltage U _i	32 VDC
- Overvoltage category	III
- Degree of pollution	3

Electrical data

Power to lock Yes

Electrical data - AS interface

AS-i Supply voltage	26.5 ... 31.6 VDC, Protection against polarity reversal
AS-i operating current	≤ 100
AS-i Device insulation	internally short-circuit proof
AS-i Specification	
- version	V 2.1
- Profile	S-7.B.F.E
- IO-Code	0x7
- ID-Code	0xB
- ID-Code1	0xF
- ID-Code2	0xE
AS-i Inputs	
- Channel 1	Data bits DI 0/DI 1= dynamic code transmission
- Channel 2	Data bits DI 2/DI 3= dynamic code transmission
AS-i Outputs	
- DO 0	Solenoid control
- DO 1	for the variable setting of the latching force
- DO 2	for the variable setting of the latching force
- DO 3	for the variable setting of the latching force
AS-i Parameter bits	
- P0	Actuator in
- P1	Solenoid interlock locked
- P2	Auxiliary voltage in
- P3	device error (Error detected)
AS-i input module address	0
- Default on address 0, programmable via the AS-Interface Master or Hand-held programming device	

Electrical data - Auxiliary voltage (Aux)

Supply voltage U_B	24 VDC (-15 % / +10 %) stabilised PELV
Operating current	≤ 600
Device insulation	≤ 4 A (if used in accordance with UL 508)

LED switching conditions display

LED switching conditions display (Y/N)	Yes
AS-i LED switching conditions display	
(1) green/red LED (AS-i duo LED)	Supply voltage / Communication error / slave address = 0
(2) yellow LED	Device status
(3) red LED	device error

ATEX

Explosion protection categories for gases	None
Explosion protected category for dusts	None

Dimensions

Dimensions of the sensor	
- Width of sensor	40
- Height of sensor	179

Pin assignment

1	AS-i +
2	Aux - (P)
3	AS-i -
4	Aux + (P)

notice

As long as the actuating unit remains inserted in the solenoid interlock, the unlocked safety guard can be relocked. The safety outputs then will be enabled again; opening the safety guard therefore is not required.

Interlocks with power to lock principle may only be used in special cases after a thorough evaluation of the accident risk, since the guarding device can immediately be opened on failure of the electrical power supply or when the main switch is opened.



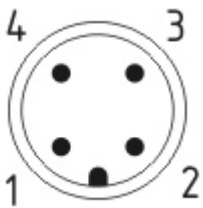

Included in delivery

Actuators must be ordered separately.

Diagram



Note Diagram

-  positive break NC contact
-  active
-  no active
-  Normally-open contact
-  Normally-closed contact

Ordering code

MZM 100 (1) ST-AS (2)(3)AP

(1)

without

B Guard locking monitored

Actuator monitored

(2)

without

without latching (Only for Guard locking monitored)

electrically adjustable latching force 30 N ... 100 N

(3)

without

without Permanent magnet

M Permanent magnet 30 N

Documents

Code: mrl_mzm100as_nl

Operating instructions and Declaration of conformity (nl) 348 kB, 31.08.2018

Code: mrl_mzm100as_nl

Operating instructions and Declaration of conformity (en) 373 kB, 28.08.2018

Code: mrl_mzm100as_en

Operating instructions and Declaration of conformity (pt) 363 kB, 31.08.2018

Code: mrl_mzm100as_pt

Operating instructions and Declaration of conformity (jp) 414 kB, 27.01.2012

Code: mrl_mzm100as_jp

Operating instructions and Declaration of conformity (es) 367 kB, 28.08.2018

Code: mrl_mzm100as_es

Operating instructions and Declaration of conformity (da) 359 kB, 28.08.2018

Code: mrl_mzm100as_da

Operating instructions and Declaration of conformity (de) 362 kB, 28.08.2018

Code: mrl_mzm100as_de

Operating instructions and Declaration of conformity (pl) 371 kB, 31.08.2018

Code: mrl_mzm100as_pl

Operating instructions and Declaration of conformity (fr) 357 kB, 31.08.2018

Code: mrl_mzm100as_fr

Operating instructions and Declaration of conformity (fr) 983 kB, 20.12.2010

Code: mrl_mzm100as_fr

Operating instructions and Declaration of conformity (it) 356 kB, 31.08.2018

Code: mrl_mzm100as_it

Images

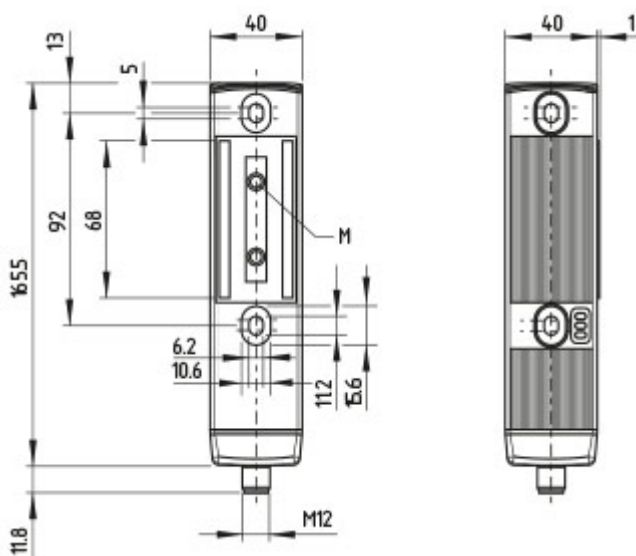

Dimensional drawing (basic component)

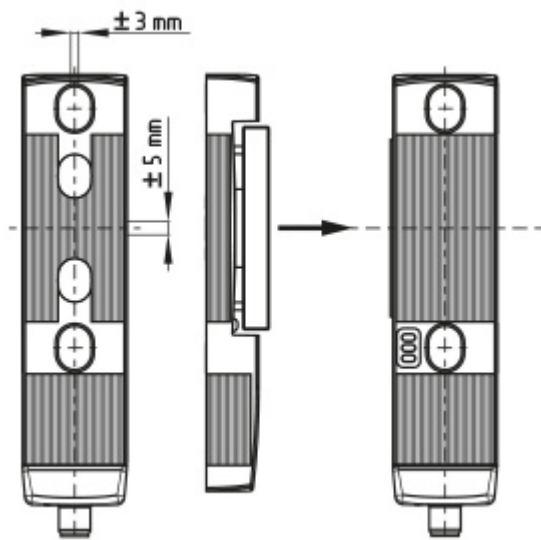

Dimensional drawing (miscellaneous)

System components

Actuator



101204290 - MZM 100-B1.1

- actuator free from play
- neutralisation of undesired noises

Accessories



101185510 - MS MZM 100-W