

Datasheet - PS215-Z11-H200

Position switch / PS215 Metal enclosure - EN 50047 with Actuator / PS215 Roller lever H200



- Metal enclosure
- Quick connection technology as connection terminals rotated by 45°
- Simple and quick to adjust the control elements by 45°.
- cable entry 1 x M20 x 1,5
- Design to EN 50047

(Minor differences between the printed image and the original product may exist!)

Ordering details

Product type description	PS215-Z11-H200
Article number	103014970
EAN Code	4030661501963
eCl@ss	27-27-06-01

Approval

Approval



Classification

Standards	ISO 13849-1
B10d Normally-closed contact (NC)	20.000.000
Mission time	20 Years
notice	$MTTF_d = \frac{B_{10d}}{0,1 \times n_{op}}$ $n_{op} = \frac{d_{ap} \times h_{op} \times 3600 \text{ s/h}}{t_{cycle}}$

Global Properties

Permanent light	PS215 with Roller lever H200
Standards	IEC 60947-5-1
Compliance with the Directives (Y/N)	Yes
Suitable for safety functions (Y/N)	Yes
Actuator type	A To EN 50047
Materials	
- Material of the housings	Metal film, Zinkdruckguss
- Material of the contacts	Silver
Housing coating	painted
Housing construction form	Norm construction design
Weight	252 g

Mechanical data

Design of electrical connection	Screw connection
Cable section	
- Min. Cable section	0,34 mm ²
- Max. Cable section	1.5 mm ²
Mechanical life	10.000.000 operations
Switching frequency	max. 5000 /h
Design of actuating element	Roller lever H200
Positive break force	> 40 N
Actuating speed for vertical actuation	
- Min. Actuating speed	10 mm/min
- Max. Actuating speed	1 m/s

Ambient conditions

Ambient temperature	
- Min. environmental temperature	-30 °C
- Max. environmental temperature	+80 °C
Protection class	IP66, IP67

Electrical data

Design of control element	1 Normally open contact (NO), 1 Opener (NC)
Switching principle	Snap switch element
- positive break NC contact	
Number of auxiliary contacts	1 piece
Number of safety contacts	1 piece
Rated impulse withstand voltage U_{imp}	4 kV
Rated insulation voltage U_i	300 V
Thermal test current I_{the}	10 A
Utilisation category	AC-15: 240 V / 3 A, DC-13: 24 V / 3 A
Required rated short-circuit current	400 A
Max. fuse rating	6 A gG D-fuse



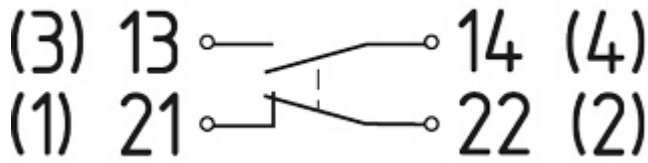

Dimensions

Dimensions of the sensor	
- Width of sensor	31 mm
- Height of sensor	112.5 mm
- Length of sensor	32.5 mm

Diagram





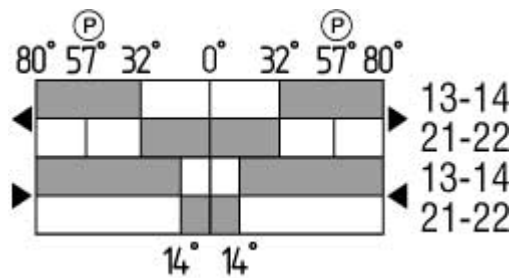

Note Diagram

-  positive break NC contact
-  active
-  no active
-  Normally-open contact
-  Normally-closed contact

Switch travel diagram



Notes Switch travel diagram

-  Contact closed
-  Contact open
-  Setting range
-  Break point
-  Positive opening sequence/- angle
- VS** adjustable range of NO contact
- VÖ** adjustable range of NC contact
- N** after travel

Ordering code

PS2(1)(2)-(3)-(4)-(5)-(6)

(1)

1

slim design

2

large design

(2)

5

Metal enclosure

6

Thermoplastic enclosure

(3)

T02

Slow action 2 Opener (NC)

T02H

Slow action with staggered contacts 2 Opener (NC)

T03

Slow action 3 Opener (NC)

T10

Slow action 1 Normally open contact (NO)

T11

Slow action 1 Normally open contact (NO) / 1 Opener (NC)

T11UE

Slow action with overlapping contacts 1 Normally open contact (NO) / 1

	Opener (NC)
T12	Slow action 1 Normally open contact (NO) / 2 Opener (NC)
T20	Slow action 2 Normally open contact (NO)
T21	Slow action 2 Normally open contact (NO) / 1 Opener (NC)
Z02	Snap action 2 Opener (NC)
Z11	Snap action 1 Normally open contact (NO) / 1 Opener (NC)
Z11R	Snap action 1 Normally open contact (NO) / 1 Opener (NC) with Latching
Z12	Snap action 1 Normally open contact (NO) / 2 Opener (NC)
(4)	
ST	connector plug M12, bottom
STR	connector plug M12, right
(5)	
S20	Plunger S200
R20	Roller plunger R200
K20	Offset roller lever K200
K21	Offset roller lever K210
K23	Angle roller lever K230
K24	Angle roller lever K240
K25	Angle roller lever K250
H20	Roller lever H200
N20	Roller lever N200
J20	Rod lever J200
(6)	
0	Material Castor/Roller: Plastic
1	Material Castor/Roller: Stainless steel
2	Material Castor/Roller: Brass
3	Material Castor/Roller: Aluminium
4	Material Castor/Roller: Steel

Documents

Declaration of conformity (en) 88 kB, 22.11.2017

Code: konfi_mrl_ps116_en

Declaration of conformity (de) 87 kB, 22.11.2017

Code: konfi_mrl_ps116_de

CCC certification (cn) 3 MB, 29.08.2017

Code: q_ps2p02

CCC certification (en) 3 MB, 29.08.2017

Code: q_ps2p01

Images



Product photo

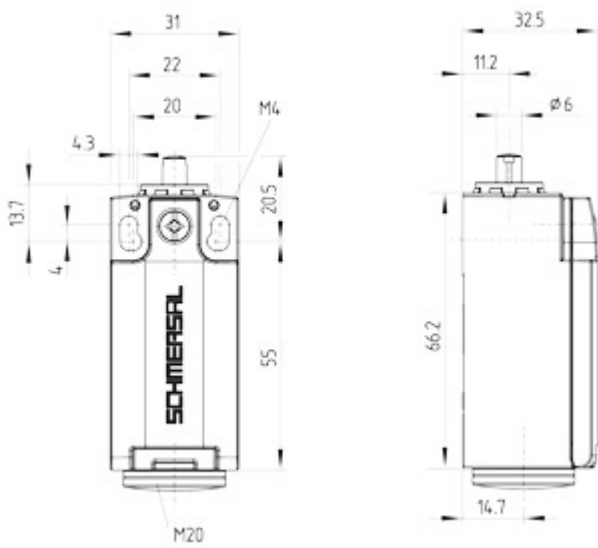

Dimensional drawing (basic component)

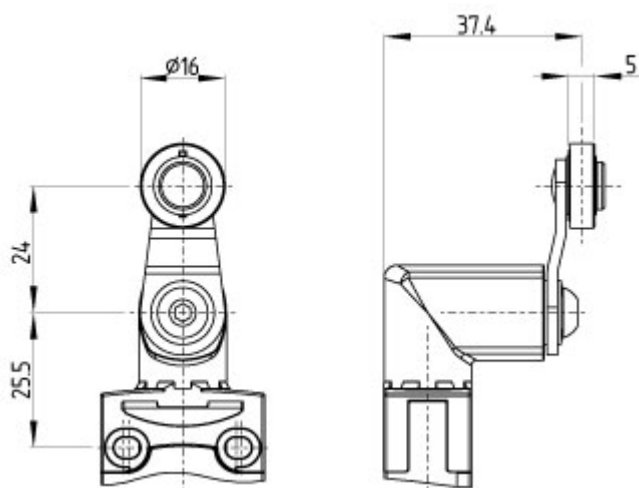

Dimensional drawing (actuator)