

Datasheet - BPS 303 SS

Safety sensors / BNS 30 / Actuator



Preferred typ

- Suitable for food processing industry



(Minor differences between the printed image and the original product may exist!)

Ordering details

Product type description	BPS 303 SS
Article number	101141156
EAN Code	4030661121079
eCl@ss	27-27-92-17

Global Properties

Permanent light	Magnet
Materials	
- Material of the housings	Stainless steel
Weight	62

Dimensions

Dimensions of the actuators	
- Width of the actuator	15
- Diameter of the actuator	37

Included in delivery

tamperproof screws	1 piece
--------------------	---------

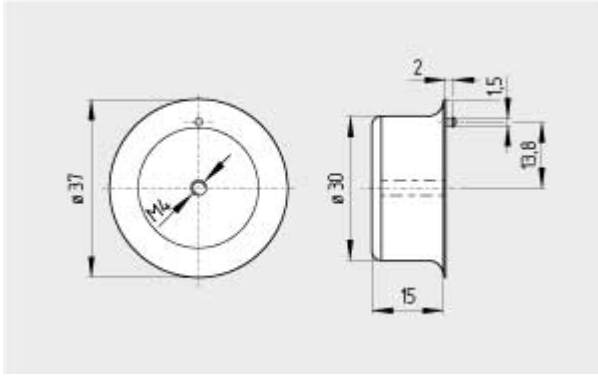

Dimensional drawing (miscellaneous)

K.A. Schmersal GmbH & Co. KG, Möddinghofe 30, D-42279 Wuppertal

The data and values have been checked thoroughly. Technical modifications and errors excepted.

Generiert am 13.02.2019 - 14:24:13h Kasbase 3.3.0.F.64I