

Datasheet - UV7H 434Y



Position switch / medium heavy Position switch / Universal range U - Metal enclosure / U 434
/ U 434 Roller lever 7H



- Metal enclosure
- 4 Contacts
- 62 mm x 127 mm x 50 mm (basic component)
- Switching points and contact function adjustable
- 3 cable entries M 20 x 1.5
- Actuator head can be repositioned in steps 4 x 90°
- Continuous adjustment of lever position 360°
- Lever can be transposed by 180°

(Minor differences between the printed image and the original product may exist!)

Ordering details

Product type description	UV7H 434Y
Article number	101060637
EAN Code	4030661349800
eCl@ss	27-27-06-01

Approval

Approval



Global Properties

Permanent light	U 434 Rollenschwenkhebel 7H
Standards	EN 60947-5-1
Compliance with the Directives (Y/N) 	Yes
Suitable for safety functions (Y/N)	No
Standard housing (Y/N)	No
Materials	
- Material of the housings	light alloy die-casting
- Roller material	Plastic
- Material of the contacts	Silver
Housing coating	painted

Weight	620
Slide form	Castor

Mechanical data

Design of electrical connection	Screw connection
Cable section	
- Min. Cable section	1.5
- Max. Cable section	2.5
AWG-Number	13
Active principle	mechanical
Mechanical life	10.000.000 operations
Contact life	2.000.000 operations, at 6 A / 400 V, $\cos \varphi = 0,4$
notice	All indications about the cable section are including the conductor ferrules.
Design of actuating element	Roller lever
Contact opening	2 x 1.5
Actuating speed with vertical actuating angle to switch axis	
- Min. Actuating speed	1
- Max. Actuating speed	3
- Actuating angle from left of switch axis	30
- Actuating angle from right of switch axis	30

Ambient conditions

Ambient temperature	
- Min. environmental temperature	-20
- Max. environmental temperature	+60
Protection class	IP65 to IEC/EN 60529

Electrical data

Design of control element	Opener (NC) Normally open contact (NO)
Switching principle	Creep circuit element
Number of shutters	2
Number of openers	2
Rated insulation voltage U_i	500 V
Thermal test current I_{the}	16 A
Max. fuse rating	16 A gG D-fuse

Dimensions

Dimensions of the sensor	
- Width of sensor	62
- Height of sensor	262
- Length of sensor	50
Roller wide	9
Roller diameter	36

notice

Type of contact and switching points can be factory set to order.

Indication legend



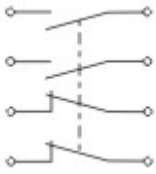

see drawing: Operating principle

Contact function, i. e. NC or NO contact, and switching points can be adjusted using a screwdriver

Diagram





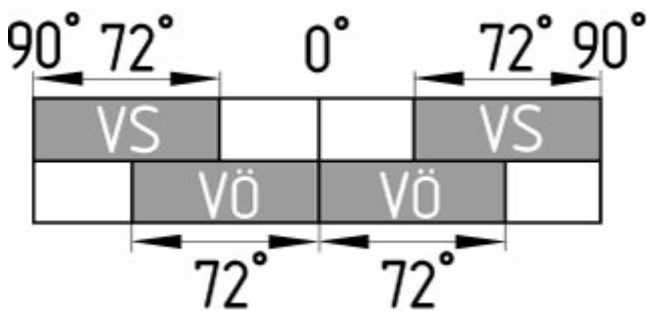

Note Diagram

-  positive break NC contact
-  active
-  no active
-  Normally-open contact
-  Normally-closed contact

Switch travel diagram



Notes Switch travel diagram

-  Contact closed
-  Contact open
-  Setting range
-  Break point
-  Positive opening sequence/- angle
- VS** adjustable range of NO contact
- VÖ** adjustable range of NC contact
- N** after travel

Ordering suffix

The applicable ordering suffix is added at the end of the part number of the safety switch.

Order example: UV7H 434Y- 1272

...- 1272

Version for low temperatures to -30°C

...-RMS

Available with metal roller

Ordering code

U(1) 434Y-(2)-(3)

(1)

S	Plunger S
K	Offset roller lever K
8H	Roller lever 8H
H	Roller lever H
3H	Roller lever 3H
7H	Roller lever 7H
4H	Spring rod lever on shaft 4H
9H	Rod lever 9H
10H	Rod lever 10H
2H	Leaf-spring lever 2H
6H	Leaf-spring lever 6H

(2)

<i>without</i>	2 Normally open contact (NO) / 2 Opener (NC)
4OE	4 Opener (NC)
4S	4 Normally open contact (NO)
1S/3OE	1 Normally open contact (NO) / 3 Opener (NC)
3S/1OE	3 Normally open contact (NO) / 1 Opener (NC)

(3)

1272	Version for low temperatures to -30°C
------	---------------------------------------

Documents

Operating instructions and Declaration of conformity (nl) 95 kB, 20.07.2018

Code: mrlk_posi-allgemein_nl

Operating instructions and Declaration of conformity (ru) 133 kB, 09.07.2018

Code: mrlk_posi-allgemein_ru

Operating instructions and Declaration of conformity (es) 88 kB, 09.07.2018

Code: mrlk_posi-allgemein_es

Operating instructions and Declaration of conformity (en) 86 kB, 09.07.2018

Code: mrlk_posi-allgemein_en

Operating instructions and Declaration of conformity (cn) 138 kB, 09.07.2018

Code: mrlk_posi-allgemein_cn

Operating instructions and Declaration of conformity (it) 86 kB, 09.07.2018

Code: mrlk_posi-allgemein_it

Operating instructions and Declaration of conformity (jp) 285 kB, 09.07.2018

Code: mrlk_posi-allgemein_jp

Operating instructions and Declaration of conformity (pl) 118 kB, 09.07.2018

Code: mrlk_posi-allgemein_pl

Operating instructions and Declaration of conformity (fr) 85 kB, 09.07.2018

Code: mrlk_posi-allgemein_fr

Operating instructions and Declaration of conformity (pt) 86 kB, 09.07.2018

Code: mrlk_posi-allgemein_pt

Operating instructions and Declaration of conformity (de) 88 kB, 09.07.2018

Code: mrlk_posi-allgemein_de

Operating instructions (pl) 369 kB, 30.11.2018

Code: mrlk_u431-u434_pl

Operating instructions (en) 352 kB, 06.08.2018

Code: mrlk_u431-u434_en

Operating instructions (es) 350 kB, 08.08.2018

Code: mrlk_u431-u434_es

Operating instructions (nl) 365 kB, 12.11.2018

Code: mrlk_u431-u434_nl

Mounting and wiring instructions (de, en, fr) 209 kB, 17.03.2008

Code: m_43sp01

Operating instructions (de) 348 kB, 06.08.2018

Code: mrlk_u431-u434_de

Operating instructions (pt) 350 kB, 23.08.2018

Code: mrlk_u431-u434_pt

Declaration of conformity (en) 158 kB, 07.11.2017

Code: konfi_mrl_u43_en

Declaration of conformity (de) 128 kB, 07.11.2017

Code: konfi_mrl_u43_de

EAC certification (ru) 388 kB, 20.01.2016

Code: q_1527p17_ru

Images

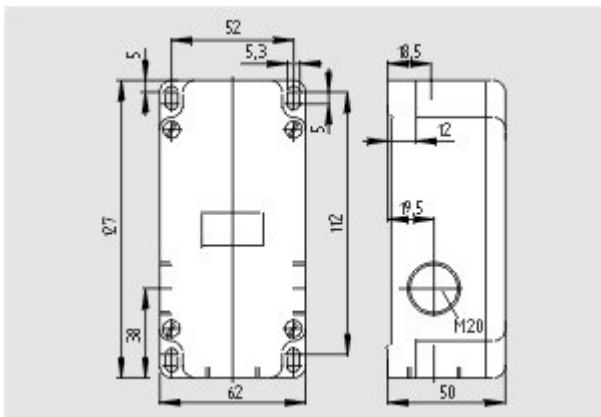

Dimensional drawing (basic component)

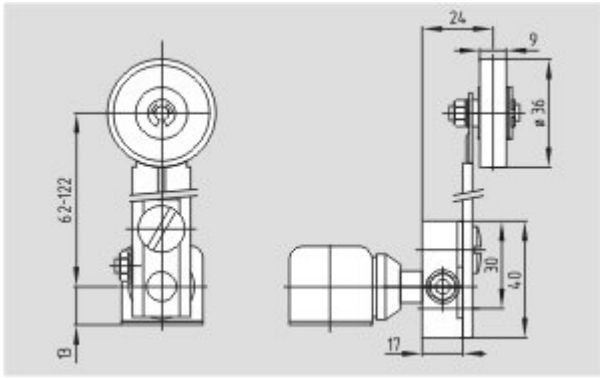

Dimensional drawing (miscellaneous)



Operating principle

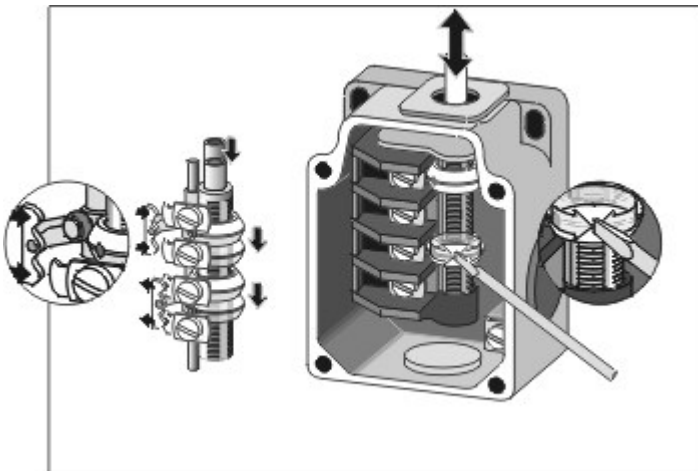

Operating principle