

Datasheet - AZM 170-11ZRIA-ST-B1 24 VAC/DC

Solenoid interlock / AZM 170I / AZM 170i-B1



- Double-insulated
- Individual coding
- Coding level "High" according to ISO 14119
- 90 mm x 84 mm x 30 mm
- Compact design
- Interlock with protection against incorrect locking.
- Long life
- High holding force
- Particularly suitable for sliding doors
- Connector M12, 4-pole
- A- and B-coding of the connectors

(Minor differences between the printed image and the original product may exist!)

Ordering details

Product type description	AZM 170-11ZRIA-ST-B1 24 VAC/DC
Article number	101144300
EAN Code	4030661132488
eCl@ss	27-27-26-03

Approval

Approval

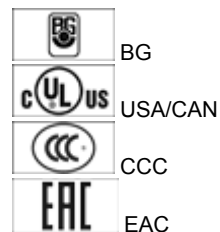

Classification

Standards	EN ISO 13849-1
B10d Normally-closed contact (NC)	2.000.000
Mission time notice	20 Years

$$MTTF_d = \frac{B_{10d}}{0,1 \times n_{op}}$$

$$n_{op} = \frac{d_{op} \times h_{op} \times 3600 \text{ s/h}}{t_{cycle}}$$

Global Properties

Permanent light	AZM 170I
Standards	EN 60947-5-1, BG-GS-ET-19
Compliance with the Directives (Y/N) 	Yes
Number of actuating directions	2
Active principle	electromechanical
- Individual coding	
- Coding level "High" according to ISO 14119	
Duty cycle ED	Magnet 100 %
Materials	
- Material of the housings	Plastic, glass-fibre reinforced thermoplastic, self-extinguishing
- Material of the actuator	Stainless steel
- Material of the contacts	Silver
Housing coating	None
Weight	279

Mechanical data

Design of electrical connection	Connector M12
Mechanical life	> 1.000.000 operations
Emergency unlocking device (Y/N)	No
Manual release (Y/N)	No
Emergency release (Y/N)	No
Latching force	30
Positive break force	8.5
positive break travel	11 mm
Clamping force F	1000 N
Max. Actuating speed	2 m/s
Minimum actuating radius	140 mm

Ambient conditions

Ambient temperature	
- Min. environmental temperature	-25 °C
- Max. environmental temperature	+60 °C
Protection class	IP67 to IEC/EN 60529

Electrical data

Design of control element	Normally open contact (NO), Opener (NC)
Switching principle	Creep circuit element
Number of auxiliary contacts	1
Number of safety contacts	1
Power to unlock	No
Power to lock	Yes
Rated control voltage U _s	24 VAC/DC
Power consumption	max. 10 W
Power consumption	max. 10 W
Rated impulse withstand voltage U _{imp}	4 kV

Rated insulation voltage U_i	250 V
Thermal test current I_{the}	10 A
Utilisation category	AC-15: 230 V / 4 A
Max. fuse rating	6 A gG D-fuse

ATEX

Explosion protection categories for gases	None
Explosion protected category for dusts	None

Miscellaneous data

Applications	 sliding safety guard,  removable guard,  hinged safety guard
--------------	--

Dimensions

Dimensions of the sensor	
- Width of sensor	108
- Height of sensor	75.5
- Length of sensor	30 mm

notice

On hinged guards, minimum actuating radius at 90° to the plane of the actuator 140 mm
minimum actuating radius on hinged guards in line with the plane of the actuator 200 mm

The actuator is not available separately.

The axis of the hinge should be 10 mm above the top edge of the safety switch and in the same plane

Included in delivery



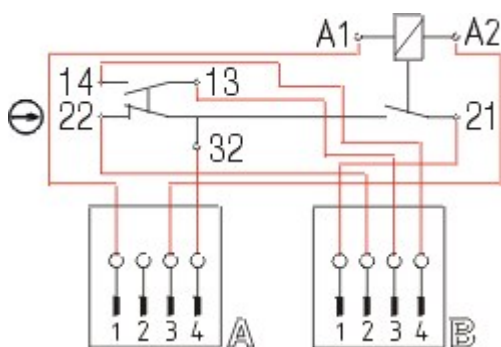

- Included in delivery
- Individually coded actuator
 - tamperproof screws
 - Slot sealing plugs

Diagram



Note Diagram



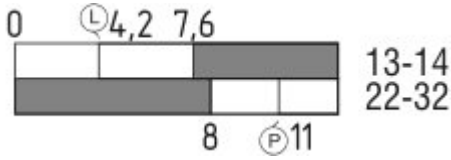

 positive break NC contact

-  active
-  no active
-  Normally-open contact
-  Normally-closed contact

Switch travel diagram



Notes Switch travel diagram

-  Contact closed
-  Contact open
-  Setting range
-  Break point
-  Positive opening sequence/- angle
- VS** adjustable range of NO contact
- VÖ** adjustable range of NC contact
- N** after travel

Ordering suffix

The applicable ordering suffix is added at the end of the part number of the safety switch.

Order example: AZM 170-11ZRIA-ST-B1 24 VAC/DC-**1637**

....-**1637**

0,3 µm gold-plated contacts

Ordering code

AZM 170(1)-(2)Z(3)I(4)-(5)-(6)-(7) (8)

(1)		
without		IDC method of termination
SK		Screw connection
(2)		
11		1 Normally open contact (NO) / 1 Opener (NC)
02		2 Opener (NC)
(3)		
without		Latching force 5 N
R		Latching force 30 N
I		Individual coding
(4)		
without		Power to unlock
A		Power to lock
(5)		
without		cable gland
ST		Connector M12 x 1
(6)		
B1		with Actuator B1

B5	with Actuator B5
B6L	with Actuator B6L
B6R	with Actuator B6R
(7)	
<i>without</i>	Manual release
2197	Manual release from side (Power to unlock)
1637	gold-plated contacts
(8)	
24VAC/DC	U _s 24 VAC/DC
110VAC	U _s 110 VAC
230VAC	U _s 230 VAC
	AZM 170ST and AZM 170SK
	AZM 170ST-(1)Z(2)I(3)-(4)-(5)-(6) 24 VAC/DC
	AZM 170SK-(1)Z(2)I(3)-(4)-(5)-(6) 24 VAC/DC
(1)	
11/11	1 Normally open contact (NO), 1 Opener (NC) / 1 Normally open contact (NO), 1 Opener (NC)
11/02	1 Normally open contact (NO), 1 Opener (NC) / 2 Opener (NC)
12/00	1 Normally open contact (NO), 2 Opener (NC) / -
12/11	1 Normally open contact (NO), 2 Opener (NC) / 1 Normally open contact (NO), 1 Opener (NC)
12/02	1 Normally open contact (NO), 2 Opener (NC) / 2 Opener (NC)
02/01	2 Opener (NC), - / 1 Opener (NC), -
02/10	2 Opener (NC), - / 1 Normally open contact (NO), -
(2)	
<i>without</i>	Latching force 5 N
R	Latching force 30 N
(3)	
<i>without</i>	Power to unlock
A	Power to lock
(4)	
B1	with Actuator B1
B5	with Actuator B5
B6L	with Actuator B6L
B6R	with Actuator B6R
(5)	
1637	gold-plated contacts
(6)	
2197	Manual release for Power to unlock

Documents

Operating instructions and Declaration of conformity (fr) 886 kB, 18.11.2016

Code: mrl_azm170i_fr

Operating instructions and Declaration of conformity (it) 863 kB, 21.11.2016

Code: mrl_azm170i_it

Operating instructions and Declaration of conformity (es) 881 kB, 21.10.2016

Code: mrl_azm170i_es

Operating instructions and Declaration of conformity (nl) 865 kB, 18.11.2016

Code: mrl_azm170i_nl

Operating instructions and Declaration of conformity (da) 867 kB, 17.11.2016

Code: mrl_azm170i_da

Operating instructions and Declaration of conformity (de) 941 kB, 11.10.2016

Code: mrl_azm170i_de

Operating instructions and Declaration of conformity (pt) 870 kB, 21.11.2016

Code: mrl_azm170i_pt

Operating instructions and Declaration of conformity (pl) 906 kB, 21.11.2016

Code: mrl_azm170i_pl

Operating instructions and Declaration of conformity (jp) 1 MB, 20.04.2016

Code: mrl_azm170i_jp

Operating instructions and Declaration of conformity (en) 957 kB, 11.10.2016

Code: mrl_azm170i_en

BG-test certificate (en) 260 kB, 09.12.2015

Code: z_m17p02

BG-test certificate (de) 257 kB, 09.12.2015

Code: z_m17p01

CCC certification (en) 5 MB, 26.10.2018

Code: q_371p02

CCC certification (cn) 5 MB, 26.10.2018

Code: q_371p03

EAC certification (ru) 809 kB, 05.10.2015

Code: q_6040p17_ru

Images

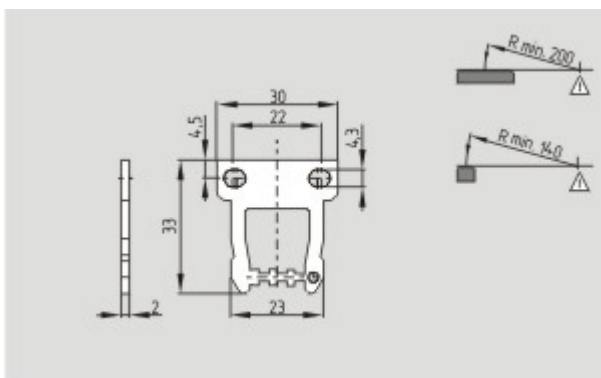

Dimensional drawing (actuator)

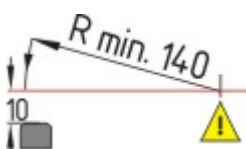

Actuating radius

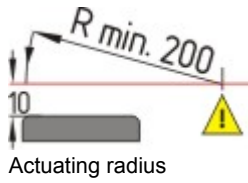

System components

Accessories



101208493 - AZM 170-B CENTERING GUIDE

- for AZ 17 and AZM 170



101100887 - TRIANGULAR KEY TK-M5

- For manual release using M5 triangular key, available as accessory
- For maintenance, installation, etc.

Connector



A-K4M12

- Pre-wired cable
- 4-pole



S-K4M12

- Connector without cable
- 4-pole