

Datasheet - SZ 415-2

Solenoid interlock / AZM 415 / Door-handle system STS / Accessories / Lockout tag SZ 415



Preferred typ



- Suitable for mounting inside and outside of the hazardous area
- To prevent inadvertent closing, e.g. during maintenance
- For complex plant
- Prevents actuation of the switch
- Lockout tag with 3 circular holes

(Minor differences between the printed image and the original product may exist!)

Ordering details

Product type description	SZ 415-2
Article number	101147932
EAN Code	4030661144993
eCl@ss	27-27-92-91

Global Properties

Permanent light	Sperrzange SZ 415
Weight	95

Mechanical data

Door hinge	left
------------	------

Documents

Mounting and wiring instructions (en) 199 kB, 03.05.2018

Code: mrl_sz415-1-2_en

Mounting and wiring instructions (pl) 211 kB, 13.08.2018

Code: mrl_sz415-1-2_pl

Mounting and wiring instructions (fr) 290 kB, 25.05.2018

Code: mrl_sz415-1-2_fr

Mounting and wiring instructions (es) 290 kB, 25.05.2018

Code: mrl_sz415-1-2_es

Mounting and wiring instructions (it) 288 kB, 25.05.2018

Code: mrl_sz415-1-2_it

Mounting and wiring instructions (pt) 170 kB, 14.08.2018

Code: mrl_sz415-1-2_pt

Mounting and wiring instructions (nl) 171 kB, 23.07.2018

Code: mrl_sz415-1-2_nl

Mounting and wiring instructions (de) 197 kB, 03.05.2018

Code: mrl_sz415-1-2_de

Images

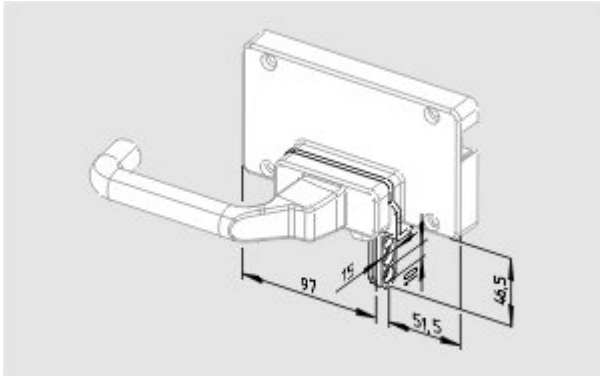

Dimensional drawing (miscellaneous)

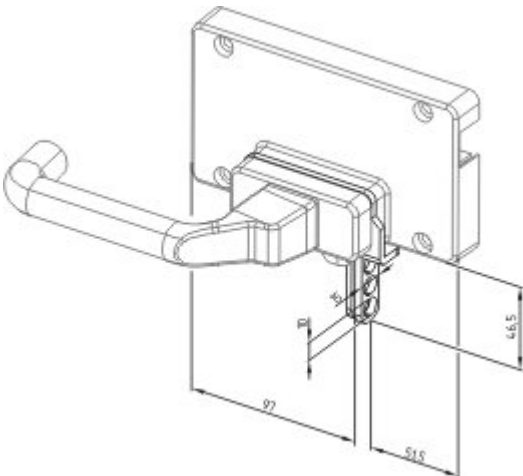

Dimensional drawing (miscellaneous)

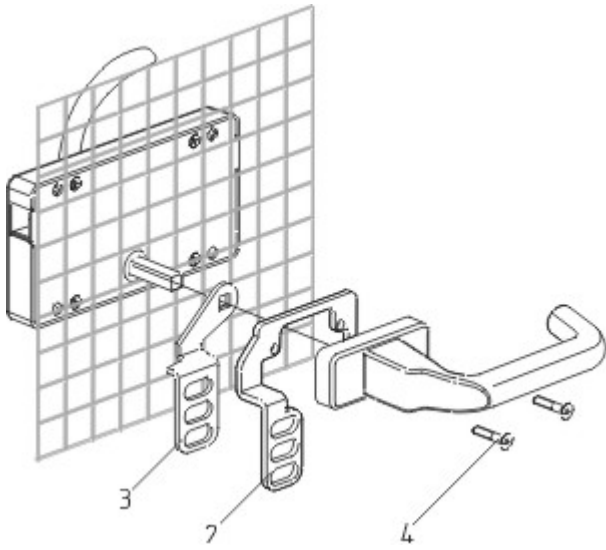

Assembly example

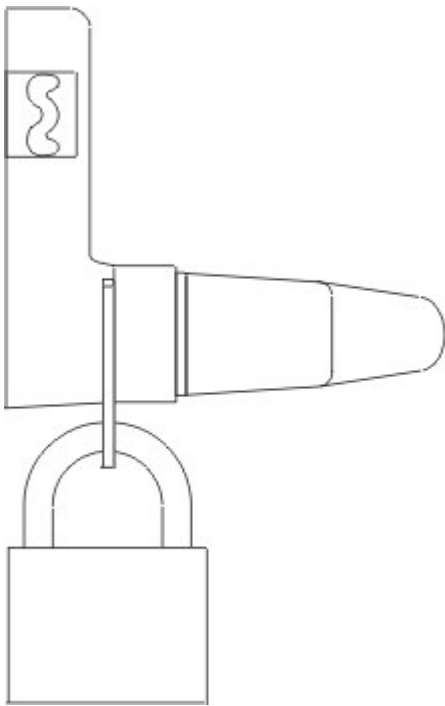

Operating principle

K.A. Schmersal GmbH & Co. KG, Mödinghofe 30, D-42279 Wuppertal

The data and values have been checked thoroughly. Technical modifications and errors excepted.

Generiert am 13.02.2019 - 14:48:36h Kasbase 3.3.0.F.64I