

## Datasheet - PS316-T11-S200



Position switch / PS316 Thermoplastic enclosure - EN 50041 with Actuator / PS316 Plunger S200



- thermoplastic enclosure with foldable latching cover
- Quick connection technology as connection terminals rotated by 45°
- Simple and quick to adjust the control elements by 45°.
- cable entry 1 x M20 x 1,5
- Design To EN 50041

(Minor differences between the printed image and the original product may exist!)

### Ordering details

Product type description	PS316-T11-S200
Article number	103015417
EAN Code	4030661503097
eCl@ss	27-27-06-01

### Approval

Approval



### Classification

Standards	ISO 13849-1
B10d Normally-closed contact (NC)	20.000.000
Mission time	20 Years
notice	$MTTF_d = \frac{B_{10d}}{0,1 \times n_{op}}$ $n_{op} = \frac{d_{op} \times h_{op} \times 3600 \text{ s/h}}{t_{cycle}}$

## Global Properties

---

Permanent light	PS316 with Plunger S200
Standards	IEC 60947-5-1
Compliance with the Directives (Y/N)	Yes
Suitable for safety functions (Y/N)	Yes
Materials	
- Material of the housings	Plastic, glass-fiber-reinforced
- Material of the contacts	Silver
Housing coating	None
Housing construction form	Norm construction design
Weight	82 g

## Mechanical data

---

Design of electrical connection	Screw connection
Cable section	
- Min. Cable section	0,34 mm <sup>2</sup>
- Max. Cable section	1.5 mm <sup>2</sup>
Mechanical life	10.000.000 operations
Switching frequency	max. 5000 /h
Design of actuating element	plunger S200
Positive break force	50 N
Actuating speed for vertical actuation	
- Min. Actuating speed	60 mm/min
- Max. Actuating speed	0,5 m/s

## Ambient conditions

---

Ambient temperature	
- Min. environmental temperature	-30 °C
- Max. environmental temperature	+80 °C
Protection class	IP66, IP67

## Electrical data

---

Design of control element	1 Normally open contact (NO), 1 Opener (NC)
Switching principle	Creep circuit element
- positive break NC contact	
Number of auxiliary contacts	1 piece
Number of safety contacts	1 piece
Rated impulse withstand voltage $U_{imp}$	4 kV
Rated insulation voltage $U_i$	300 V
Thermal test current $I_{the}$	10 A
Utilisation category	AC-15: 240 V / 3 A, DC-13: 24 V / 3 A
Required rated short-circuit current	400 A
Max. fuse rating	6 A gG D-fuse (quick-blow)

## Dimensions



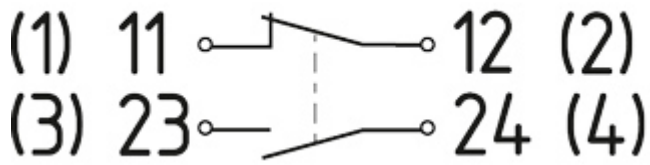

---

Dimensions of the sensor	
- Width of sensor	41 mm
- Height of sensor	87 mm
- Length of sensor	37 mm

## Diagram





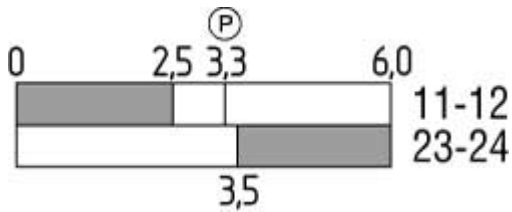

### Note Diagram

-  positive break NC contact
-  active
-  no active
-  Normally-open contact
-  Normally-closed contact

## Switch travel diagram



### Notes Switch travel diagram

-  Contact closed
-  Contact open
-  Setting range
-  Break point
-  Positive opening sequence/- angle
- VS** adjustable range of NO contact
- VÖ** adjustable range of NC contact
- N** after travel

## Ordering code

PS3(1)(2)-(3)-(4)-(5)-(6)

(1)

1

2

(2)

5

6

(3)

T02

T02H

T03

T10

T11

T11UE

T12

slim design

large design

Metal enclosure

Thermoplastic enclosure

Slow action 2 Opener (NC)

Slow action with staggered contacts 2 Opener (NC)

Slow action 3 Opener (NC)

Slow action 1 Normally open contact (NO)

Slow action 1 Normally open contact (NO) / 1 Opener (NC)

Slow action with overlapping contacts 1 Normally open contact (NO) / 1 Opener (NC)

Slow action 1 Normally open contact (NO) / 2 Opener (NC)

<b>T20</b>	Slow action 2 Normally open contact (NO)
<b>T21</b>	Slow action 2 Normally open contact (NO) / 1 Opener (NC)
<b>Z02</b>	Snap action 2 Opener (NC)
<b>Z11</b>	Snap action 1 Normally open contact (NO) / 1 Opener (NC)
<b>Z11R</b>	Snap action 1 Normally open contact (NO) / 1 Opener (NC) with Latching
<b>Z12</b>	Snap action 1 Normally open contact (NO) / 2 Opener (NC)
<b>(4)</b>	
<b>ST</b>	connector plug M12, bottom
<b>STR</b>	connector plug M12, right
<b>(5)</b>	
<b>S20</b>	Plunger S200
<b>R30</b>	Roller plunger R300
<b>K36</b>	Angle roller lever K360
<b>K37</b>	Offset roller lever K370
<b>H30</b>	Roller lever H300
<b>N30</b>	Roller lever N300
<b>J30</b>	Rod lever J300
<b>(6)</b>	
<b>0</b>	Material Castor/Roller: Plastic
<b>1</b>	Material Castor/Roller: Stainless steel
<b>2</b>	Material Castor/Roller: Brass
<b>3</b>	Material Castor/Roller: Aluminium
<b>4</b>	Material Castor/Roller: Steel

## Documents

---

**Operating instructions** (de) 425 kB, 14.01.2019

Code: mrlk\_ps315-316-g\_de

**Operating instructions** (en) 431 kB, 14.01.2019

Code: mrlk\_ps315-316-g\_en

**Declaration of conformity** (en) 88 kB, 22.11.2017

Code: konfi\_mrl\_ps116\_en

**Declaration of conformity** (de) 87 kB, 22.11.2017

Code: konfi\_mrl\_ps116\_de

**CCC certification** (cn) 3 MB, 29.08.2017

Code: q\_ps3p02

**CCC certification** (en) 3 MB, 29.08.2017

Code: q\_ps3p01

## Images

---



Product photo

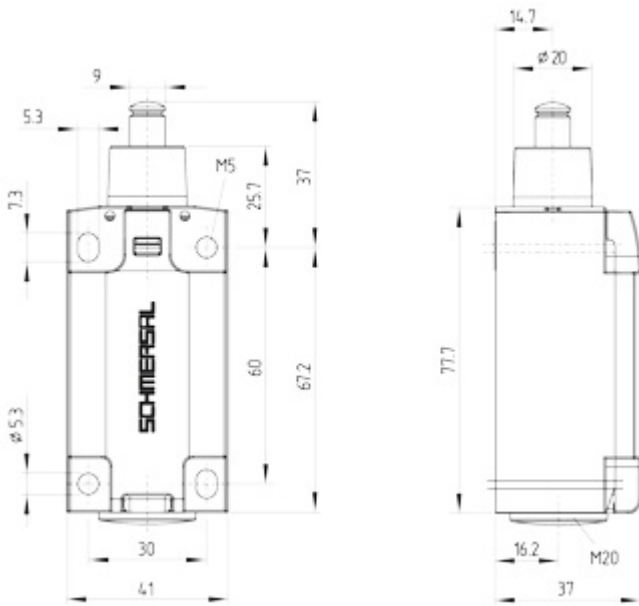

Dimensional drawing (basic component)

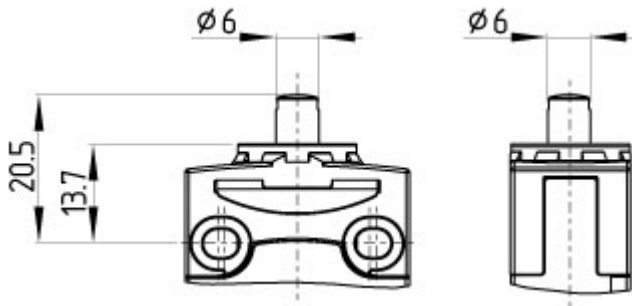

Dimensional drawing (actuator)

K.A. Schmersal GmbH & Co. KG, Möddinghofe 30, D-42279 Wuppertal

The data and values have been checked thoroughly. Technical modifications and errors excepted.

Generiert am 13.02.2019 - 13:56:15h Kasbase 3.3.0.F.64I