

Datasheet - BN 325-R-1389

Magnetic reed switch / BN 325



- Flat plug-in connector 6.3 mm and 2 shielding plates
- Non-contact principle
- 1 Reed kontakts
- Long life
- Actuating surface and direction of actuation marked by switch symbol
- 85 mm x 26 mm x 24 mm
- Thermoplastic enclosure
- Spade connector

(Minor differences between the printed image and the original product may exist!)

Ordering details

Product type description	BN 325-R-1389
Article number	101147103
EAN Code	4030661141411
eCl@ss	27-27-01-04

Approval

Approval	-
----------	---

Global Properties

Permanent light	BN 325
Standards	-
Compliance with the Directives (Y/N) 	Yes
suitable for elevators (Y/N)	No
Mounting	rear with 2 Threaded bolt
Active principle	Magnetic drive
Materials	
- Material of the housings	Plastic, glass-fibre reinforced thermoplastic
Housing construction form	rectangular, flat
Weight	44
Recommended actuator	BP 10 N, BP 10 S, 2 x BP 10 N, 2 x BP 10 S, BP 15 N, BP 15 S, 2 x BP 15/2 N, 2 x BP 15/2 S, BP 34 N, BP 34 S, BP 20 N, BP 20 S, BP 31 N, BP 31 S, BP 11 N, BP 11 S, 2 x BP 11 N, 2 x BP 11 S, BP 12 N, BP 12 S, 2 x BP 12 N, 2 x BP 12 S, BP 21 N, BP 21 S, 2 x BP 21 N, 2 x BP 21 S, BE 20, BE 20 N(S) ST 24VDC, BE 20 N(S) 48VDC

Mechanical data

Design of electrical connection	Flat plug-in connector 6.3 mm and 2 shielding plates
Mechanical life	1.000.000.000 operations
Electrical lifetime	1.000.000 ... 1.000.000.000 operations
Switching frequency	300/

Actuating planes	Actuation from side
Active area	lateral
Switch distance	5 ... 55 BP 10N = 10 mm BP 10S = 10 mm 2 x BP 10N = 15 mm 2 x BP 10S = 15 mm BP 15N = 12 mm BP 15S = 12 mm 2 x BP 15/2N = 17 mm 2 x BP 15/2S = 17mm BP 34N = 10 ... 25mm BP 34S = 10 ... 25 mm BP 20N = 5 ... 20 mm BP 20S = 5 ... 20 mm BP 31N = 5 ... 20 mm BP 31S = 5 ... 20 mm BP 11N = 10 mm BP 11S = 10 mm 2 x BP 11N = 20 mm 2 x BP 11S = 20 mm BP 12N = 15 mm BP 12S = 15 mm 2 x BP 12N = 10 ... 25 mm 2 x BP 12S = 10 ... 25 mm BP 21N = 15 ... 40 mm BP 21S = 15 ... 40 mm 2 x BP 21N = 20 ... 55 mm 2 x BP 21S = 20 ... 55 mm BE 20 = 20 mm BE 20N = 15 mm BE 20S = 15 mm
- notice	Actuating distance up to 55 mm depending on actuating magnet and version
Type of actuation	Magnet
restistance to shock	50 / 11
Resistance to vibration	10 ... 55 HZ, Amplitude 1 mm
Bounce duration	0,3 ... 0,6
Latching (Y/N)	Yes
Actuating speed	18
Switching point accuracy	± 0,25 mm

Ambient conditions

Ambient temperature	
- Min. environmental temperature	-25
- Max. environmental temperature	+70
Protection class	IP40

Electrical data

Design of control element	bistable contact
Number of snap-in contacts	1
Switching time - Close	1.5
Switching time - Open	0,5
Voltage type	
Dielectric strength	> 600 (50)
Switching voltage	250
Switching current	3 A
Switching capacity	120 /

Outputs

Design of control output	Reed contacts
--------------------------	---------------

LED switching conditions display

LED switching conditions display (Y/N)	No
--	----

ATEX

Explosion protection categories for gases	None
Explosion protected category for dusts	None

Dimensions

Dimensions of the sensor	
- Width of sensor	85
- Height of sensor	26
- Length of sensor	24

notice

The opening and closing functions depend on the direction of actuation, the actuating magnets and the polarity of the actuating magnets.



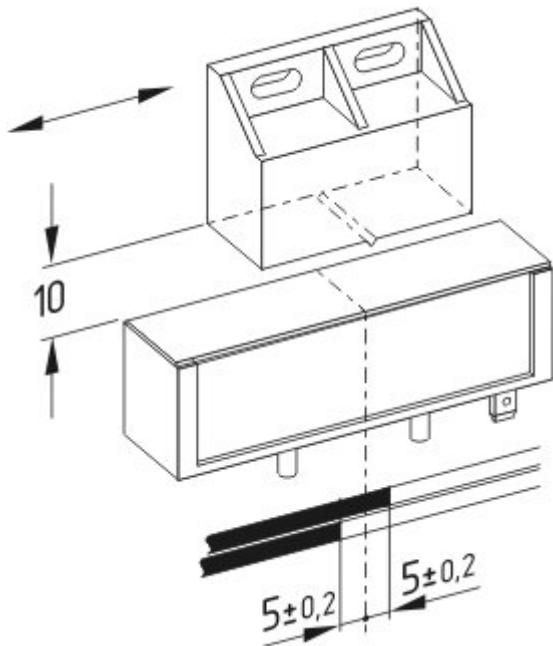

Included in delivery

Actuators must be ordered separately.

Diagram



Note Diagram

-  positive break NC contact
-  active
-  no active
-  Normally-open contact
-  Normally-closed contact

Documents

Operating instructions and Declaration of conformity (en) 224 kB, 22.11.2017

Code: mrl_bn325-r-g_en

Operating instructions and Declaration of conformity (fr) 228 kB, 05.03.2018

Code: mrl_bn325-r-g_fr

Operating instructions and Declaration of conformity (jp) 308 kB, 03.11.2015

Code: mrl_bn325-r-g_jp

Operating instructions and Declaration of conformity (pl) 259 kB, 17.05.2018

Code: mrl_bn325-r-g_pl

Operating instructions and Declaration of conformity (pt) 227 kB, 09.01.2018

Code: mrl_bn325-r-g_pt

Operating instructions and Declaration of conformity (it) 223 kB, 09.01.2018

Code: mrl_bn325-r-g_it

Operating instructions and Declaration of conformity (es) 192 kB, 10.09.2014

Code: mrl_bn325-r-g_es

Operating instructions and Declaration of conformity (es) 226 kB, 21.12.2017

Code: mrl_bn325-r-g_es

Operating instructions and Declaration of conformity (nl) 221 kB, 08.08.2018

Code: mrl_bn325-r-g_nl

Operating instructions and Declaration of conformity (de) 195 kB, 22.11.2017

Code: mrl_bn325-r-g_de

Declaration of conformity (en) 186 kB, 12.07.2018

Code: __bn_p01_en

Declaration of conformity (de) 102 kB, 08.06.2016

Code: __bn_p01

notice - Switch distance (de) 36 kB, 07.08.2009

Code: s_bnbsp01

notice - Switch distance (nl) 39 kB, 07.08.2009

Code: s_bnbsp04

notice - Switch distance (en) 42 kB, 07.08.2009

Code: s_bnbsp02

notice - Switch distance (fr) 41 kB, 07.08.2009

Code: s_bnbsp03

notice - Switch distance (pt) 39 kB, 07.08.2009

Code: s_bnbsp10

notice - Switch distance (it) 40 kB, 07.08.2009

Code: s_bnbsp05

Images

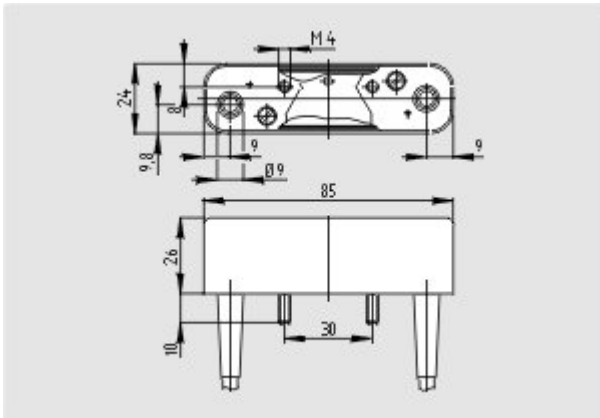

Dimensional drawing (basic component)

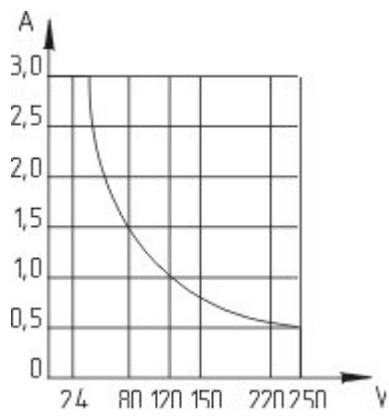

Characteristic curve

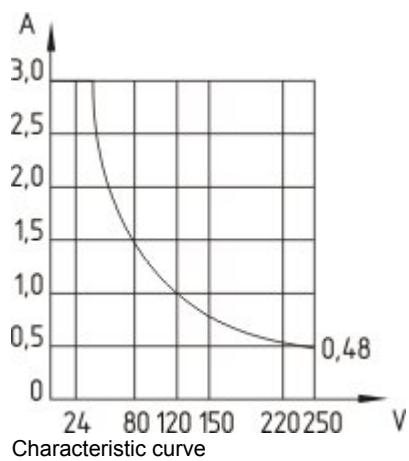

Characteristic curve

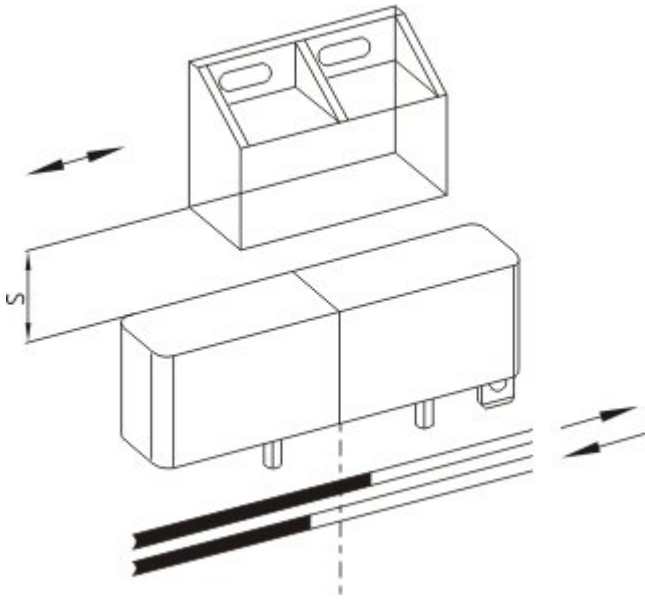

Diagram

System components

Actuator

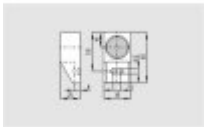

101057534 - BP 21 S

- -metal housing
- S-pole marked red
- Suitable for mounting on ferrous material

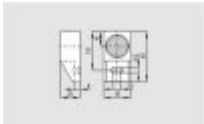

101057536 - BP 21 N

- -metal housing
- N-pole marked green
- Suitable for mounting on ferrous material

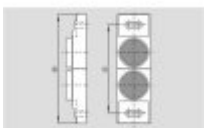

101059917 - BP 12 N

- -metal housing
- N-pole marked green
- Suitable for mounting on ferrous material

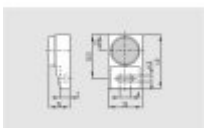

101057533 - BP 11 S

- -metal housing
- S-pole marked red
- Suitable for mounting on ferrous material

101059923 - BP 11 N

- -metal housing
- N-pole marked green
- Suitable for mounting on ferrous material

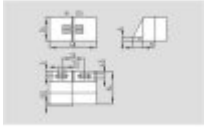

101057521 - BP 31 S

- thermoplastic enclosure
- S-pole marked red
- Suitable for mounting on ferrous material with a distance of 20 mm

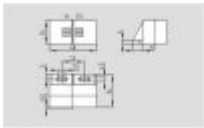

101057520 - BP 31 N

- thermoplastic enclosure
- N-pole marked green
- Suitable for mounting on ferrous material with a distance of 20 mm

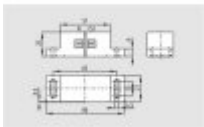

101057541 - BP 20 S

- -metal housing
- S-pole marked red
- Suitable for mounting on ferrous material with a distance of 20 mm

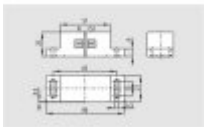

101057538 - BP 20 N

- -metal housing
- N-pole marked green
- Suitable for mounting on ferrous material with a distance of 20 mm

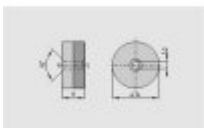

101057553 - BP 34

- thermoplastic enclosure
- S-pole marked red
- N-pole marked green
- Suitable for mounting on ferrous material with a distance of 25 mm

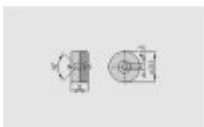

101060163 - BP 15

- thermoplastic enclosure
- N-pole marked green
- S-pole marked red
- Suitable for mounting on ferrous material with a distance of 18 mm



101057531 - BP 10

- Unenclosed
- Colour coding of poles by labels

K.A. Schmersal GmbH & Co. KG, Möddinghofe 30, D-42279 Wuppertal

The data and values have been checked thoroughly. Technical modifications and errors excepted.

Generiert am 13.02.2019 - 13:12:00h Kasbase 3.3.0.F.64I