

Datasheet - SE-P40-NBR-5000

Safety-related tactile sensor / Safety edges / SE-P40

 Preferred typ

- Dirt and moisture in the profile are to a great extent compensated
- Insensitive to environmental conditions
- approx. 40 mm high



(Minor differences between the printed image and the original product may exist!)

Ordering details

Product type description	SE-P40-NBR-5000
Article number	101174455
EAN Code	4030661303741
A safety edge system consists of individual components. The components must be ordered separately.	
Example:	
Rubber profile, SE-P40-1250	
Al profile, SE-AL 10-1250	
Emitter/ Receiver SE-SET	
Safety-monitoring module, SE-304 C	
Options:	
Caps SE-T40; Sticker SE-G8406	
Other accessories	
eCl@ss	27-27-34-01

Global Properties

Permanent light	Gummiprofil SE-P40
Standards	EN ISO 13850
Compliance with the Directives (Y/N)	No
Materials	
- Material of the rubber profile	NBR perbunan@
Weight	1780
Coated profile (Y/N)	No

Mechanical data

Mechanical life	20.000.000 operations
max. permanent load	500 on the operational switching zone
Response travel	max. 9 mm
After-travel	max. 18 mm

Ambient conditions

Protection class	IP67
notice	The protection class IP 67 applies to the entire signal transmitter.

Dimensions

Dimensions	
- Width	25 mm
- Height	approx. 40 mm
- Length	5000 mm

notice

In the extremities of the safety edge at approx. 60 mm (SE 40) or 50 mm (SE 70) finger guard is not guaranteed. Upon actuation of this area, the transmitter/receiver is pushed into the lower profile section and the switching signal is evaluated, but the required forces are high though. If this restriction is not acceptable for the specific application, constructive measures must be taken.

Ordering code

SE-P40 (1)-(2)-(3)

(1)

without

C

Profile uncoated

Profile coated

(2)

without

NBR

Material: EPDM, 65 Shore A

Material: perbunan® NBR

(3)

1250

Length 1250 mm

2500

Length 2500 mm

5000

Length 5000 mm (*Only for Profile uncoated*)

10000

Length 10000 mm (*Only for Profile uncoated*)

Documents

Operating instructions and Declaration of conformity (jp) 263 kB, 09.09.2014

Code: mrl_se40-70_jp

Operating instructions and Declaration of conformity (fr) 218 kB, 03.12.2014

Code: mrl_se40-70_fr

Operating instructions and Declaration of conformity (it) 219 kB, 28.08.2014

Code: mrl_se40-70_it

Operating instructions and Declaration of conformity (de) 205 kB, 29.07.2014

Code: mrl_se40-70_de

Operating instructions and Declaration of conformity (cn) 258 kB, 24.06.2015

Code: mrl_se40-70_cn

Operating instructions and Declaration of conformity (es) 221 kB, 28.08.2014

Code: mrl_se40-70_es

Operating instructions and Declaration of conformity (nl) 201 kB, 16.10.2014

Code: mrl_se40-70_nl

Operating instructions and Declaration of conformity (en) 203 kB, 29.07.2014

Code: mrl_se40-70_en

Mounting and wiring instructions (de, en, fr) 30 kB, 30.04.2009

Code: m_se_p03

Force-travel diagram (en) 106 kB, 14.08.2009

Code: k_se_p02

Force-travel diagram (fr) 81 kB, 14.08.2009

Code: k_se_p03

Force-travel diagram (pt) 73 kB, 14.08.2009

Code: k_se_p10

Force-travel diagram (nl) 72 kB, 14.08.2009

Code: k_se_p04

Force-travel diagram (it) 72 kB, 14.08.2009

Code: k_se_p05

Force-travel diagram (es) 72 kB, 14.08.2009

Code: k_se_p09

Force-travel diagram (de) 105 kB, 14.08.2009

Code: k_se_p01

Images



Product photo

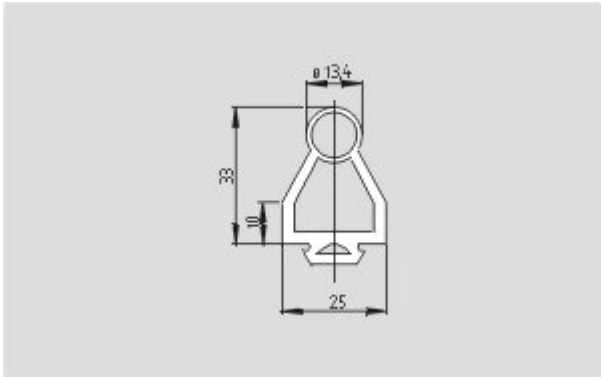

Dimensional drawing (basic component)

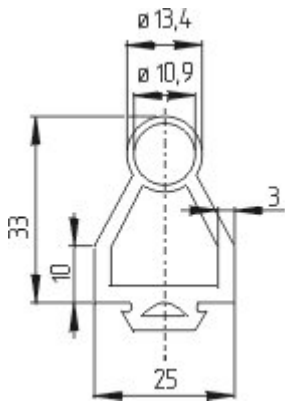

Dimensional drawing (basic component)

K.A. Schmersal GmbH & Co. KG, Möddinghofe 30, D-42279 Wuppertal

The data and values have been checked thoroughly. Technical modifications and errors excepted.

Generiert am 13.02.2019 - 14:40:44h Kasbase 3.3.0.F.64I