

## Datasheet - IFL 2-8M-10N

Inductive proximity switch / Housing construction form: cylinder, thread / IFL - M8

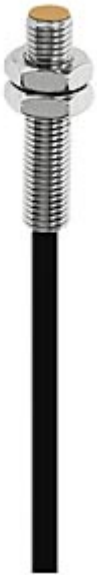

Preferred typ



(Minor differences between the printed image and the original product may exist!)

- Design M 8 x 1
- Metal enclosure
- DC 3-wire
- miniature body

### Ordering details

Product type description	IFL 2-8M-10N
Article number	101113527
EAN Code	4030661085524
eCl@ss	27-27-01-01

### Global Properties

Permanent light	IFL - M8
Standards	IEC/EN 60947-5-2; DIN VDE 0660-208
Compliance with the Directives (Y/N) 	Yes
Operating resource protection class	None
Materials	
- Material of the housings	Brass
- Material of the nuts	Brass
- Material of the cable mantle	PVC
- Material of the active surface	Plastic
Housing coating	nickel-plated
Housing construction form	cylinder, thread
Weight	55

### Mechanical data

Design of electrical connection	Cable
Cable length	2
Conductor with strain relief	No
Conductors	3 x 0,14
mechanical installation conditions	flush
Switch distance $S_n$	2 mm
Reduction factor 1 met (Y/N)	No
Protection circuit	inductive interference protection, Protection against polarity reversal, short-circuit and overload proof
Pressure resistant (Y/N)	No
Tightening torque for nuts	A/F 13 max. 600 Ncm

## Ambient conditions

---

Ambient temperature	
- Min. environmental temperature	-25
- Max. environmental temperature	+70
Protection class	IP67 to IEC/EN 60529

## Electrical data

---

Design of control element	Normally open contact (NO)
Number of wire	3
Voltage type	DC, direct current
Supply voltage $U_B$	
- Min. supply voltage	10
- Max. supply voltage	30
Switch frequency	approx. 3000 HZ
Voltage drop $U_d$	approx. 1.2 V (200 mA)
Operating current $I_e$	200 mA
No-load current $I_0$	approx. 3.4 mA (24 V)

## Outputs

---

Design of control output	NPN
--------------------------	-----

## LED switching conditions display

---

LED switching conditions display (Y/N)	Yes
- yellow LED	

## ATEX

---

Explosion protection categories for gases	None
Explosion protected category for dusts	None

## Dimensions

---

Dimensions of the sensor	
- Length of sensor	42
- Diameter of sensor	M8



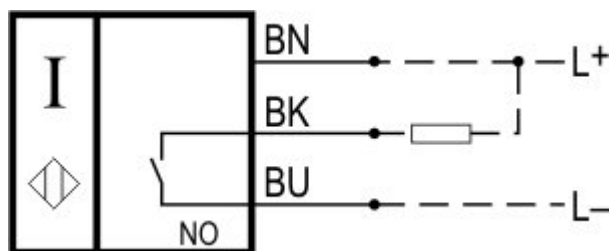

## Indication legend

May not be charged in this area!

## Diagram



Note Diagram

-  positive break NC contact
-  active
-  no active
-  Normally-open contact
-  Normally-closed contact

## Ordering code

IFL (1)-(2)(3)-(4)(5)(6)(7)

(1)	
2	Switch distance 2 mm
3	Switch distance 3 mm
B	Quasi-embeddable
(2)	
8	cylinder, thread M8
(3)	
without	Included in standard version Design
M	miniature body
(4)	
01	Opener (NC)
10	Normally open contact (NO)
10/01	Normally open contact (NO) / Opener (NC) with Wiring compartment
11	Normally open contact (NO) / Opener (NC) antivalent
(5)	
without	Cable
ST	Connector
(6)	
without	Included in standard version Plug-in connection
2	Alternative Plug-in connection
(7)	
N	n-type
P	p-type

## Documents

Operating instructions (nl) 134 kB, 01.08.2018

Code: mrl\_ifl-allgemein\_nl

**Operating instructions** (en) 128 kB, 31.08.2016

Code: mrl\_ifl-allgemein\_en

**Operating instructions** (pl) 137 kB, 21.10.2016

Code: mrl\_ifl-allgemein\_pl

**Operating instructions** (pt) 109 kB, 06.04.2017

Code: mrl\_ifl-allgemein\_pt

**Operating instructions** (it) 108 kB, 21.10.2016

Code: mrl\_ifl-allgemein\_it

**Operating instructions** (es) 110 kB, 21.10.2016

Code: mrl\_ifl-allgemein\_es

**Operating instructions** (cn) 177 kB, 05.05.2017

Code: mrl\_ifl-allgemein\_cn

**Operating instructions** (de) 131 kB, 31.08.2016

Code: mrl\_ifl-allgemein\_de

**Operating instructions** (fr) 110 kB, 21.10.2016

Code: mrl\_ifl-allgemein\_fr

**Declaration of conformity** (en) 91 kB, 13.04.2017

Code: konfi\_ifl\_en

**Declaration of conformity** (de) 96 kB, 01.07.2016

Code: konfi\_ifl\_de

## Images

---

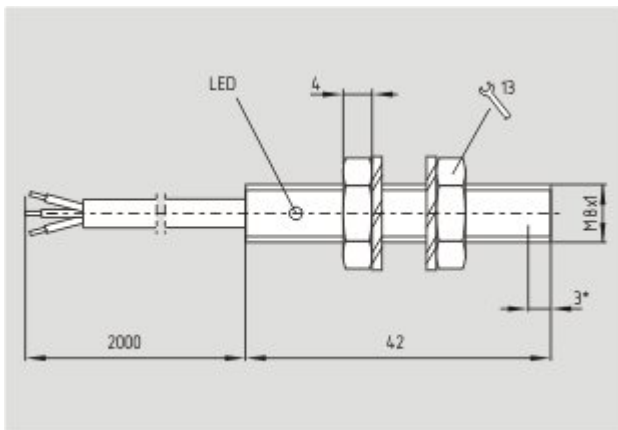

Dimensional drawing (basic component)

---

K.A. Schmersal GmbH & Co. KG, Mödinghofe 30, D-42279 Wuppertal

The data and values have been checked thoroughly. Technical modifications and errors excepted.

Generiert am 13.02.2019 - 13:08:33h Kasbase 3.3.0.F.64I