

Datasheet - SLB440-ER-2-LST

Safety light barriers / SLB 440



SLB 440 Series -

- Compact design With integral evaluation
- Height range 75 m (Reserve up to 90 m)
- Safe OSSD outputs to PLe
- Automatic start or restart interlock
- Sturdy metal enclosure with M12 connector or cable
- Version with heater for outdoor applications down to -30°C
- Set-up tool and diagnostic indication

(Minor differences between the printed image and the original product may exist!)

Ordering details

Product type description	SLB440-ER-2-LST
Article number	103013526
EAN Code	4030661492384
eCl@ss	27-27-27-01

Approval

Approval



Classification

Standards	EN ISO 13849-1, EN 62061
PL	up e
Control category	up 4
PFH value	1.5×10^{-8} 1/h
SIL	up 3
Mission time	20 Years

Global Properties

Permanent light	SLB440
Standards	EN 61496-1; EN 61496-2
Compliance with the Directives (Y/N)	Yes
Operating resource protection class	Protection class 3

Safety type in accordance with IEC 61496-1	4
Materials	
- Material of the housings	Aluminium
Weight	150
Beam coding (Y/N)	Yes
Beam coding	2
Protection field height	-
Range of the protection field	300 ... 15.000
Reaction time	7 ... 22
Wave length of the sensors	880
Fade-out is possible (Y/N)	No
Override possible (Y/N)	No
reduced resolution (Y/N)	No
Clock control possible (Y/N)	No
Muting possible (Y/N)	No
Restart block (Y/N)	Yes
Master/slave function	No
Cascadable (Y/N)	No
Monitoring function of downstream devices (Y/N)	Yes
Recommended safety-monitoring module	PSC1, SRB-E-204ST

Mechanical data

Detection ability for test bodies	40; V = 1.6 m/s
Number of beams	1
Design of electrical connection	
- Wiring of the transmitter	cable with connector M12, 4-pole
- Wiring of the receiver	cable with connector M12, 5-pole
Cable length	100

Ambient conditions

Ambient temperature	
- Min. environmental temperature	-30
- Max. environmental temperature	+50
Storage and transport temperature	
- Min. Storage and transport temperature	-30
- Max. Storage and transport temperature	+70
Protection class	IP67 to IEC/EN 60529

Electrical data

Design of output switching element OSSD	PNP
Power consumption	
- Power consumption Transmitter	< 5
- Power consumption Receiver	< 5
Voltage type	DC
Switching voltage of the OSSD in high state	24 V \pm 10%

Outputs

Max. output current at secured output	200
---------------------------------------	-----

Electrical data - Safety outputs

Number of secure semi-conductor outputs	2
Number of secure outputs with contact	-

LED switching conditions display

LED switching conditions display (Y/N)	Yes
Status and diagnostics	Yes
7-segment display	No

ATEX

Explosion protection categories for gases	None
Explosion protected category for dusts	None

Dimensions

Dimensions	
- Width	27.8
- Height	72
- Length	33

Documents

Operating instructions (de, en) 1 MB, 04.04.2017

Code: mrl_slb440_de-en

BG-test certificate (en, de) 816 kB, 28.06.2017

Code: z_slbp02

Brochure (fr) 453 kB, 05.10.2017

Code: b_opto_slb_240_440_450_fr

Brochure (cn) 655 kB, 10.08.2017

Code: b_opto_slb_240_440_450_cn

Brochure (en) 466 kB, 31.07.2017

Code: b_opto_slb_240_440_450_en

Brochure (pt) 458 kB, 06.09.2017

Code: b_opto_slb_240_440_450_pt

Brochure (es) 468 kB, 08.08.2017

Code: b_opto_slb_240_440_450_es

Brochure (de) 497 kB, 06.07.2017

Code: b_opto_slb_240_440_450_de

Brochure (it) 458 kB, 29.08.2017

Code: b_opto_slb_240_440_450_it

EAC certification (ru) 1 MB, 15.03.2018

Code: q_slbp01

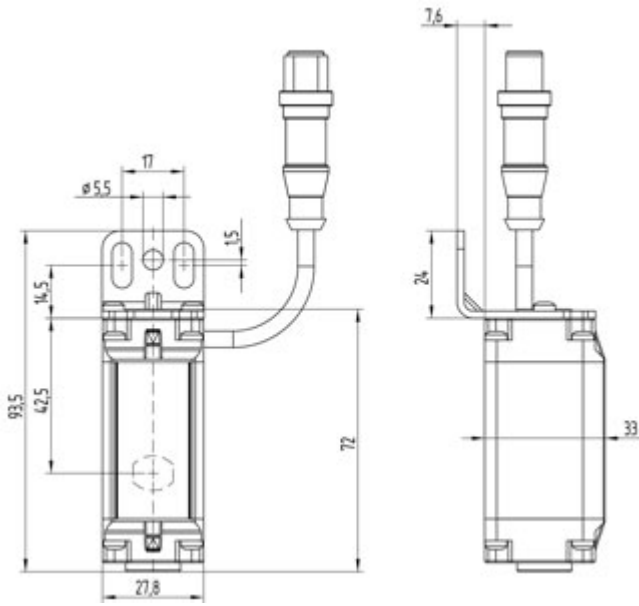

Dimensional drawing (basic component)

K.A. Schmersal GmbH & Co. KG, Möddinghofe 30, D-42279 Wuppertal

The data and values have been checked thoroughly. Technical modifications and errors excepted.

Generiert am 13.02.2019 - 14:15:47h Kasbase 3.3.0.F.64I