

Datasheet - MV8H 330-11Y

Position switch / light Position switch / M 330 / M 330 Roller lever 8H



Preferred typ



- Metal enclosure
- Long life
- 40 mm x 76 mm x 40 mm (basic component)
- Suitable for low actuating speeds
- 1 Cable entry M 20 x 1.5
- free of silicon
- proved in power station applications
- Actuator head can be repositioned in steps 4 x 90°
- Continuous adjustment of lever position 360°
- Lever can be transposed by 180°

(Minor differences between the printed image and the original product may exist!)

Ordering details

Product type description	MV8H 330-11Y
Article number	101167334
EAN Code	4030661218847
eCl@ss	27-27-06-01

Approval

Approval



Global Properties

Permanent light	M 330 Rollenschwenkhebel 8H
Standards	EN 60947-5-1
Compliance with the Directives (Y/N)	Yes
Suitable for safety functions (Y/N)	No
Standard housing (Y/N)	No
Materials	
- Material of the housings	cast iron
- Roller material	Plastic
- Material of the contacts	Silver
Housing coating	painted

Weight	277
Slide form	Castor

Mechanical data

Design of electrical connection	Screw connection
Cable section	
- Min. Cable section	1.5
- Max. Cable section	2.5
AWG-Number	13
Active principle	mechanical
Mechanical life	> 30.000.000 operations
notice	All indications about the cable section are including the conductor ferrules.
Design of actuating element	Roller lever
actuating torque	50.5
restistance to shock	50 g / 6 ms
Bounce duration	≤ 1.5
Switchover time	≤ 10
Contact opening	2 x 0,5
Repeat accuracy of switching points	± 0,02
Actuating speed	
- Min. Actuating speed	1
- Max. Actuating speed	

Ambient conditions

Ambient temperature	
- Min. environmental temperature	-30
- Max. environmental temperature	+90
Protection class	IP65 to IEC/EN 60529

Electrical data

Design of control element	Normally open contact (NO), Opener (NC)
- Change-over contact with double break	
- galvanically separated contact bridges	
Switching principle	Snap switch element
Number of shutters	1
Number of openers	1
Rated impulse withstand voltage U_{imp}	4 kV
Rated insulation voltage U_i	250 V
Thermal test current I_{the}	6 A
Utilisation category	AC-15: 230 V / 2,5 A
Max. fuse rating	6 A gG D-fuse





Dimensions

Dimensions of the sensor	
- Width of sensor	40
- Height of sensor	129.5
- Length of sensor	40
Roller wide	8.5
Roller diameter	20

Diagram





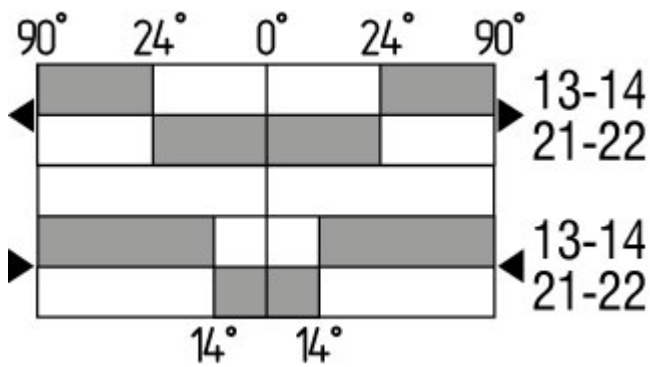

Note Diagram

-  positive break NC contact
-  active
-  no active
-  Normally-open contact
-  Normally-closed contact

Switch travel diagram



Notes Switch travel diagram

-  Contact closed
-  Contact open
-  Setting range
-  Break point
-  Positive opening sequence/- angle
- VS** adjustable range of NO contact
- VÖ** adjustable range of NC contact
- N** after travel

Ordering suffix

The applicable ordering suffix is added at the end of the part number of the safety switch.

Order example: MV8H 330-11Y**Au-Ni**

... Au-Ni	Gold-nickel contact tips for low DC voltages
...- RMS	Available with metal roller
...- 1164	Splined shaft and lever available with 10° tooting
...- A	actuating torque 24 Ncm

Ordering code

M(1) 330-11Y-(2)-(3)

(1)

S	Plunger S
2S	Telescopic plunger 2S
R	Roller plunger R
K	Offset roller lever K
3K	Angle roller lever 3K
3S	Side plunger 3S
3R	Side roller plunger 3R
AF	Spring rod lever AF
4D	Forked roller lever 4D
8H	Roller lever 8H
7H	Roller lever 7H
10H	Rod lever 10H
H	Roller lever H
4H	Spring rod lever on shaft 4H
2H	Leaf-spring lever 2H
3H	Roller lever 3H
9H	Rod lever 9H
6H	Leaf-spring lever 6H

(2)

<i>without</i>	without LED switching conditions display
G24	with LED switching conditions display

(3)

Ni	Contacts in Gold-nickel alloy
1164	Splined shaft and lever available with 10° toothing
1366	For temperatures up to +160°C

Documents

Operating instructions (pl) 152 kB, 07.08.2018

Code: mrlk_m330_pl

Operating instructions (de) 120 kB, 07.08.2018

Code: mrlk_m330_de

Operating instructions (nl) 122 kB, 07.08.2018

Code: mrlk_m330_nl

Operating instructions (fr) 122 kB, 07.08.2018

Code: mrlk_m330_fr

Operating instructions (pt) 121 kB, 07.08.2018

Code: mrlk_m330_pt

Operating instructions (en) 119 kB, 07.08.2018

Code: mrlk_m330_en

Operating instructions (it) 120 kB, 07.08.2018

Code: mrlk_m330_it

Operating instructions (es) 120 kB, 07.08.2018

Code: mrlk_m330_es

Declaration of conformity (en) 86 kB, 21.12.2016

Code: konfi_mrl_m330_en

Declaration of conformity (de) 97 kB, 17.11.2016

Code: konfi_mrl_m330_de

CCC certification (en) 808 kB, 02.08.2016

Code: q_332p01

CCC certification (cn) 803 kB, 02.08.2016

Code: q_332p02

EAC certification (ru) 844 kB, 05.10.2015

Code: q_6037p17_ru

Images

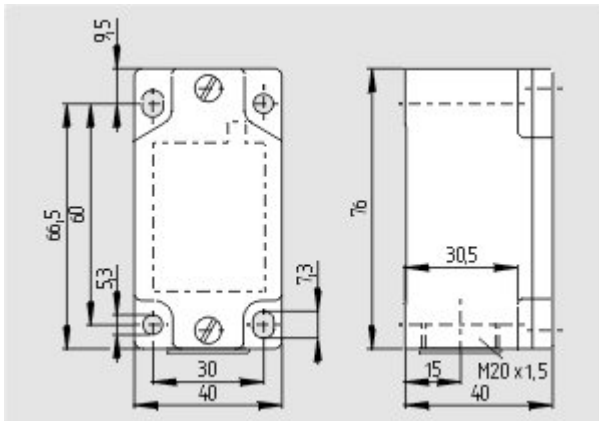

Dimensional drawing (basic component)

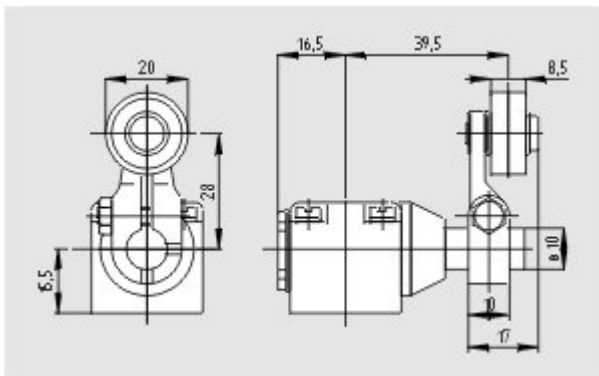

Dimensional drawing (miscellaneous)

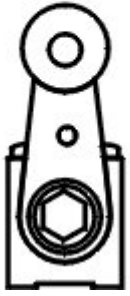

Operating principle

K.A. Schmersal GmbH & Co. KG, Möddinghofe 30, D-42279 Wuppertal

The data and values have been checked thoroughly. Technical modifications and errors excepted.

Generiert am 13.02.2019 - 13:33:39h Kasbase 3.3.0.F.64I