

Datasheet - TS 017-22Y

Position switch / medium heavy Position switch / Product series 015, 016, 017 - Metal enclosure / 017 / 017 Plunger S



- Metal enclosure
- 4 Contacts
- 67 mm x 130 mm x 43 mm (basic component)
- 3 Cable entry M 20 x 1.5

(Minor differences between the printed image and the original product may exist!)

Ordering details

Product type description	TS 017-22Y
Article number	101054927
EAN Code	4030661002491
eCl@ss	27-27-06-01

Approval

Approval



Global Properties

Permanent light	017 Druckbolzen S
Standards	EN 60947-5-1
Compliance with the Directives (Y/N) 	Yes
Suitable for safety functions (Y/N)	No
Standard housing (Y/N)	No
Materials	
- Material of the housings	light alloy die-casting, painted
- Material of the contacts	Silver
Housing coating	painted

Weight	385
Slide form	Sphere

Mechanical data

Design of electrical connection	Screw connection
Cable section	
- Min. Cable section	1.5
- Max. Cable section	2.5
AWG-Number	13
Active principle	mechanical
Mechanical life	5.000.000 operations
notice	All indications about the cable section are including the conductor ferrules.
Design of actuating element	Plunger
Actuating force	25 N
Bounce duration	
Switchover time	
Contact opening	2 x 2.5
Actuating speed with vertical actuating angle to switch axis	
- Min. Actuating speed	1
- Max. Actuating speed	1
- Actuating angle	20

Ambient conditions

Ambient temperature	
- Min. environmental temperature	-30
- Max. environmental temperature	+90
Protection class	IP65 to IEC/EN 60529

Electrical data

Design of control element	Normally open contact (NO), Opener (NC)
- Change-over contact with double break	
Switching principle	Creep circuit element
- positive break NC contact	
Number of shutters	2
Number of openers	2
Rated insulation voltage U_i	500 V
Thermal test current I_{the}	10 A
Utilisation category	AC-15: 400 V / 4 A
Max. fuse rating	20 A gG D-fuse

Dimensions

Dimensions of the sensor	
- Width of sensor	67
- Height of sensor	141
- Length of sensor	43
Slide diameter	6

notice



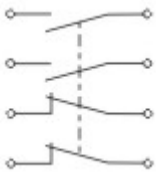

notice **Actuation from the side of the plunger should be avoided, since this**

reduces the mechanical life of the position switch.

Diagram



Note Diagram

-  positive break NC contact
-  active
-  no active
-  Normally-open contact
-  Normally-closed contact

Ordering suffix

The applicable ordering suffix is added at the end of the part number of the safety switch.

Order example: TS 017-22Y- C

...- C	Magnetic blow-out Blow-out magnets available to switch high DC currents Rated operating current/voltage I_e/U_e : 1 A / 220 V; 4 A / 24 V Utilisation category: DC-13
...- UE	Slow action with overlapping contacts
...- H	Slow action with staggered contacts

Ordering code

(1)(2) 017-(3)Y-(4)

(1)

T Slow action

M Snap action

(2)

S Plunger S

2S Telescopic plunger 2S

K Offset roller lever K

2K Rocking offset roller lever 2K

3K Angle roller lever 3K

8H Roller lever 8H

7H Roller lever 7H

10H Rod lever 10H

H Roller lever H

4H Spring rod lever on shaft 4H

2H Leaf-spring lever 2H

3H Roller lever 3H

9H Rod lever 9H

6H Leaf-spring lever 6H

(3)	
22	2 Normally open contact (NO) / 2 Opener (NC)
13	1 Normally open contact (NO) / 3 Opener (NC)
31	3 Normally open contact (NO) / 1 Opener (NC)
(4)	
UE	Slow action with overlapping contacts
H	Slow action with staggered contacts
C	Magnetic blow-out

Documents

Operating instructions and Declaration of conformity (nl) 95 kB, 20.07.2018

Code: mrlk_posi-allgemein_nl

Operating instructions and Declaration of conformity (ru) 133 kB, 09.07.2018

Code: mrlk_posi-allgemein_ru

Operating instructions and Declaration of conformity (es) 88 kB, 09.07.2018

Code: mrlk_posi-allgemein_es

Operating instructions and Declaration of conformity (en) 86 kB, 09.07.2018

Code: mrlk_posi-allgemein_en

Operating instructions and Declaration of conformity (cn) 138 kB, 09.07.2018

Code: mrlk_posi-allgemein_cn

Operating instructions and Declaration of conformity (it) 86 kB, 09.07.2018

Code: mrlk_posi-allgemein_it

Operating instructions and Declaration of conformity (jp) 285 kB, 09.07.2018

Code: mrlk_posi-allgemein_jp

Operating instructions and Declaration of conformity (pl) 118 kB, 09.07.2018

Code: mrlk_posi-allgemein_pl

Operating instructions and Declaration of conformity (fr) 85 kB, 09.07.2018

Code: mrlk_posi-allgemein_fr

Operating instructions and Declaration of conformity (pt) 86 kB, 09.07.2018

Code: mrlk_posi-allgemein_pt

Operating instructions and Declaration of conformity (de) 88 kB, 09.07.2018

Code: mrlk_posi-allgemein_de

Declaration of conformity (de) 93 kB, 27.03.2017

Code: konfi_mrl_tm015_de

Declaration of conformity (en) 91 kB, 07.11.2017

Code: konfi_mrl_tm015_en

CCC certification (en) 4 MB, 27.10.2017

Code: q_372p02

CCC certification (cn) 4 MB, 27.10.2017

Code: q_372p03

Images

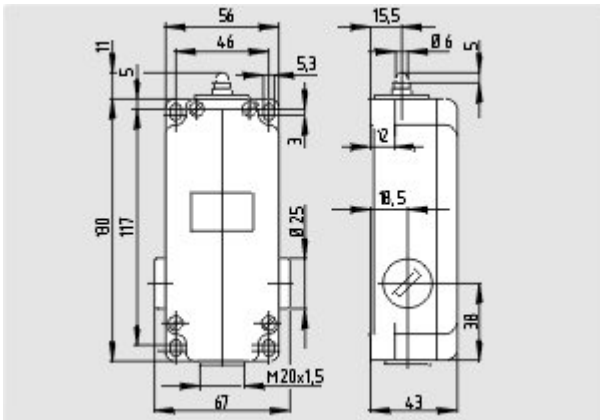

Dimensional drawing (basic component)

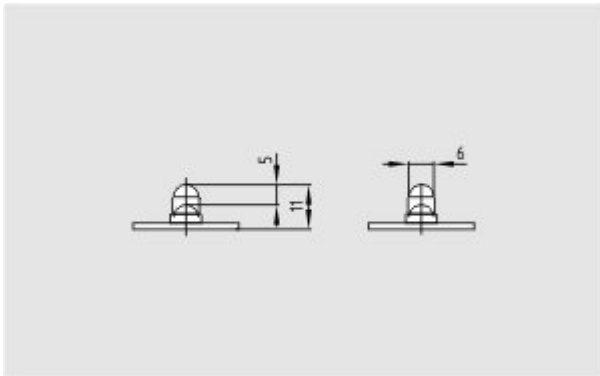

Dimensional drawing (miscellaneous)



Operating principle
