

Datasheet - ZQ 900 ST-AS



AS interface safety at work / Safety switchgear / Pull-wire emergency stop switches / ZQ 900 AS



- Metal enclosure
- one-side operation / wire up to 75 m long
- Release push button
- Position indicator
- Robust design
- Large wiring compartment
- Twisting of towing eye not possible
- External watertight collar
- wire pull and breakage detection
- Integrated AS-Interface
- Suitable for AS-i Power24
- AS-Interface M12 connector, bottom, can be rotated

(Minor differences between the printed image and the original product may exist!)

Ordering details

Product type description	ZQ 900 ST-AS
Article number	101214847
EAN Code	4030661404479
eCl@ss	27-37-12-90

Approval

Approval



Classification

Standards	EN ISO 13849-1, IEC 61508
PL	up e
Control category	up 4
PFH value	$\leq 1.4 \times 10^{-8} / h$
- notice	up to max. 5.000 switching cycles/year
SIL	up 3
Mission time	20 Years

Global Properties

Permanent light	ZQ 900 AS
Standards	EN 60947-5-1, EN ISO 13850, EN 50295, EN ISO 13849-1, IEC 61508
Compliance with the Directives (Y/N) 	Yes
Materials	
- Material of the housings	zinc die-cast, painted
- Material of the cover	Plastic, glass-fibre reinforced thermoplastic, self-extinguishing
Housing coating	painted
Weight	
Response time	< 100
Emergency-Stop button (Y/N)	No

Mechanical data

Design of electrical connection	Connector M12, 5-pole
Mechanical life	> 100.000 operations
Switching frequency	max. 1/s
Actuating force	max. 200 N
actuating travel	max. 400 mm
restistance to shock	15 g / 11 ms
Resistance to vibration	10 ... 150 HZ, Amplitude 0,35 mm / 5 g
Length of wire	max. 50 m

Ambient conditions

Ambient temperature	
- Min. environmental temperature	-25
- Max. environmental temperature	+ 60
- Min. Storage and transport temperature	-25
- Max. Storage and transport temperature	+85
Relative humidity	30 ... 95
- non-condensing	
- non-icing	
Protection type IP	IP65, IP67
Air clearances and creepage distances To IEC/EN 60664-1	
- Rated impulse withstand voltage U_{imp}	800 V
- Rated insulation voltage U_i	32 V
- Overvoltage category	III
- Degree of pollution	3

Electrical data

Switching principle	Snap switch element
positive break NC contact 	
positive break NC contact 	

Electrical data - AS interface

AS-i Supply voltage	18 ... 31.6 VDC, Protection against polarity reversal
- Min. supply voltage	18
- Max. supply voltage	31.6
AS-i operating current	≤ 50

AS-i Device insulation	internally short-circuit proof
AS-i Specification	
- version	V 3.0
- Profile	S-0.B.F.F
- IO-Code	0x0
- ID-Code	0xB
- ID-Code1	0xF
- ID-Code2	0xF
AS-i Inputs	
- Channel 1	Data bits DI 0/DI 1= dynamic code transmission
- Channel 2	Data bits DI 2/DI 3= dynamic code transmission
AS-i Outputs	DO 0 ... DO 3 not used
AS-i Parameter bits	
- P0	Channel 2 switched
- P1	not used
- P2	not used
- P3	not used
AS-i input module address	0
- Default on address 0, programmable via the AS-Interface Master or Hand-held programming device	

LED switching conditions display

LED switching conditions display (Y/N)	No
--	----

Dimensions

Dimensions of the sensor	
- Width of sensor	71.5
- Height of sensor	220.3 mm up 236 mm
- Length of sensor	97

Pin assignment

1	AS interface +
2	None
3	AS interface -
4	None
5	Functional earth connection

notice

At 5 m distance intermediate wire supports are required, see accessories

Recommended cable lengths for pull-wire Emergency-Stop switches in relation to the range of ambient temperature.

As the thimbles are subject to deformation in case of wire pull, the wire should be pulled several times after fitting. After that, the wire must be re-tensioned using the eyebolt or the tensioner.

The addressing must take place via the M12 connector or the flat cable connection.

Indication legend

A = Position indicator

B = Emergency-Stop button

C = reset button

1 = Wire rope

2 = Eyebolt

- 3 = nut
- 4 = Wire clamp
- 5 = Tensioning Jack
- 6 = Wire thimble
- 7 = shackle
- 8 = rope tensioner

Ordering code

ZQ 900 (1)-AS (2)

(1)	
ST	connector plug M12, bottom
STR	connector plug M12, right
STL	connector plug M12, left
FK	, bottom
FKR	, right
FKL	, left
(2)	
<i>without</i>	without Emergency-Stop button
N	with Emergency-Stop button

Documents

Operating instructions and Declaration of conformity (pl) 366 kB, 12.02.2018

Code: mrl_zq900as_pl

Operating instructions and Declaration of conformity (nl) 348 kB, 12.02.2018

Code: mrl_zq900as_nl

Operating instructions and Declaration of conformity (de) 327 kB, 22.11.2017

Code: mrl_zq900as_de

Operating instructions and Declaration of conformity (fr) 350 kB, 02.02.2018

Code: mrl_zq900as_fr

Operating instructions and Declaration of conformity (jp) 509 kB, 11.08.2011

Code: mrl_zq900as_jp

Operating instructions and Declaration of conformity (en) 346 kB, 22.11.2017

Code: mrl_zq900as_en

Operating instructions and Declaration of conformity (it) 346 kB, 02.02.2018

Code: mrl_zq900as_it

Operating instructions and Declaration of conformity (es) 350 kB, 02.02.2018

Code: mrl_zq900as_es

Operating instructions and Declaration of conformity (pt) 351 kB, 12.02.2018

Code: mrl_zq900as_pt

TÜV certification (en, de) 44 kB, 02.04.2014

Code: z_zq7p01

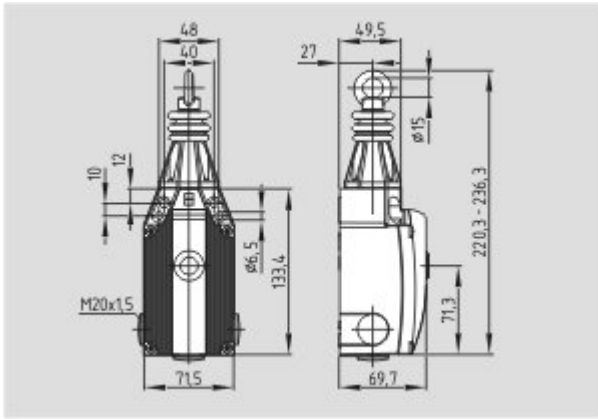

Dimensional drawing (basic component)

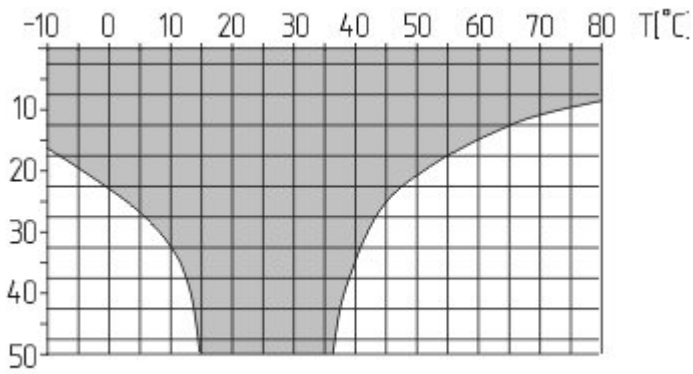

l [m]
Characteristic curve

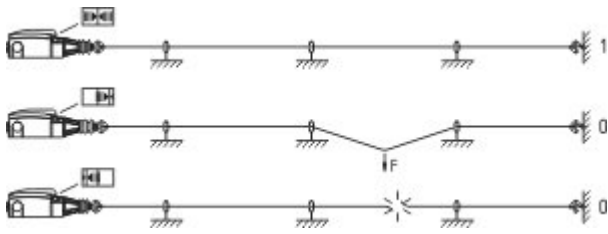

Operating principle

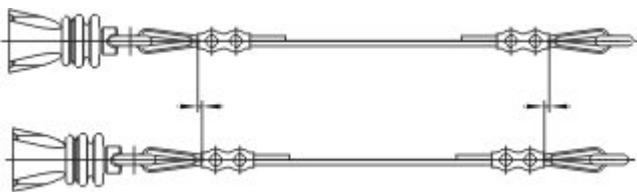

Operating principle

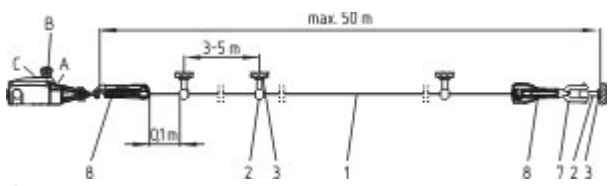

Operating principle

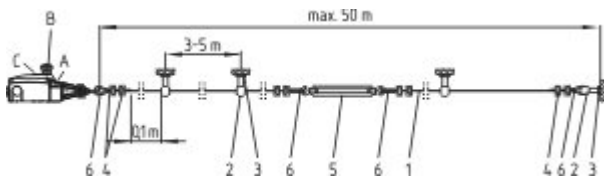

Operating principle

System components

Accessories

101162986 - Eyebolt BM 8 x 70



101192471 - Eyebolt BM 8 x 70 NIRO



101084928 - Eyebolt BM 10 x 40



101203477 - Wire clamp 3 mm NIRO



101203569 - Wire clamp 4 mm NIRO



101203478 - Wire clamp 5 mm NIRO



101190917 - Duplex wire clamp 3 mm NIRO



- for Wire rope Ø 3 mm



101203569 - Duplex wire clamp 4 mm NIRO

- for Wire rope Ø 3 mm



101196043 - Egg-shaped wire clamp GR 3

- for Wire rope Ø 3 mm



101077072 - Egg-shaped wire clamp GR 4

- for Wire rope Ø 4 mm



101203472 - WIRE THIMBLE 3 mm NIRO

- for Wire rope Ø 3 mm
- to DIN 6899



101170750 - WIRE THIMBLE 4 mm

- for Wire rope Ø 4 mm
- to DIN 6899



101203475 - WIRE THIMBLE 4 mm NIRO

- for Wire rope Ø 4 mm
- to DIN 6899



101203476 - WIRE THIMBLE 5 mm NIRO

- for Wire rope Ø 5 mm
- to DIN 6899



101192433 - PULLEY

- for Wire rope Ø 3 mm
- To guide the wire rope where the path is not a straight line



101087930 - TENSIONING JACK M6

- For exact adjustment of the tension of the wire rope
- to DIN 1480



103005863 - TENSION SPRING ACC-700-RZ173I

- To maintain the reaction force



101186490 - SHACKLE NIRO

- Shackle for fixing the wire rope to the eyebolt



101078670 - WIRE ROPE 5 mm

- With red PVC sheath
- Ø 5 mm total
- Steel core Ø 3 mm
- Quantity: Meter



103003628 - WIRE UNIT COMPLETE 5 m

- Ready-to-fit
- With red PVC sheath



103003629 - WIRE UNIT COMPLETE 10 m

- Ready-to-fit
- With red PVC sheath

103003865 - WIRE UNIT COMPLETE 15 m

- Ready-to-fit
- With red PVC sheath



103003866 - WIRE UNIT COMPLETE 20 m

- Ready-to-fit
- With red PVC sheath



101170761 - WIRE UNIT COMPLETE 25 m

- Ready-to-fit
- With red PVC sheath



103003630 - WIRE UNIT COMPLETE 30 m

- Ready-to-fit
- With red PVC sheath



103003867 - WIRE UNIT COMPLETE 40 m

- Ready-to-fit
- With red PVC sheath



103003631 - WIRE UNIT COMPLETE 50 m

- Ready-to-fit
- With red PVC sheath



101186704 - rope tensioner S 900

- Smooth adjustment
- Only one tool
- Antiskid
- Time-saving
- Ergonomic
- No risk of injury

