

## Datasheet - TV7H 017-31Y



Position switch / medium heavy Position switch / Product series 015, 016, 017 - Metal enclosure / 017 / 017 Roller lever 7H



(Minor differences between the printed image and the original product may exist!)

- Metal enclosure
- 4 Contacts
- 67 mm x 130 mm x 43 mm ( basic component)
- Actuator head can be repositioned in steps 4 x 90°
- Continuous adjustment of lever position 360°
- Lever can be transposed by 180°
- 3 Cable entry M 20 x 1.5

### Ordering details

Product type description	TV7H 017-31Y
Article number	101060389
EAN Code	4030661254951
eCl@ss	27-27-06-01

### Approval

Approval



### Global Properties

Permanent light	017 Rollenschwenkhebel 7H
Standards	EN 60947-5-1
Compliance with the Directives (Y/N) 	Yes
Suitable for safety functions (Y/N)	No
Standard housing (Y/N)	No
Materials	
- Material of the housings	light alloy die-casting, painted
- Roller material	Plastic
- Material of the contacts	Silver
Housing coating	painted

Weight	540
Slide form	Castor

## Mechanical data

---

Design of electrical connection	Screw connection
Cable section	
- Min. Cable section	1.5
- Max. Cable section	2.5
AWG-Number	13
Active principle	mechanical
Mechanical life	5.000.000 operations
notice	All indications about the cable section are including the conductor ferrules.
Design of actuating element	Roller lever
actuating torque	25
Bounce duration	
Switchover time	
Contact opening	2 x 2.5
Actuating speed with vertical actuating angle to switch axis	
- Min. Actuating speed	1
- Max. Actuating speed	3
- Actuating angle from left of switch axis	30
- Actuating angle from right of switch axis	30

## Ambient conditions

---

Ambient temperature	
- Min. environmental temperature	-30
- Max. environmental temperature	+90
Protection class	IP65 to IEC/EN 60529

## Electrical data

---

Design of control element	Normally open contact (NO), Opener (NC)
- with double break	
Switching principle	Creep circuit element
- positive break NC contact	
Number of shutters	3
Number of openers	1
Rated insulation voltage $U_i$	500 V
Thermal test current $I_{the}$	10 A
Utilisation category	AC-15: 400 V / 4 A
Max. fuse rating	20 A gG D-fuse

## Dimensions



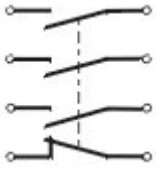

---

Dimensions of the sensor	
- Width of sensor	67
- Height of sensor	283
- Length of sensor	43
Roller wide	9
Roller diameter	36

## Diagram



Note Diagram

-  positive break NC contact
-  active
-  no active
-  Normally-open contact
-  Normally-closed contact

**Ordering suffix**

The applicable ordering suffix is added at the end of the part number of the safety switch.  
Order example: TV7H 017-31Y- C

...- C	Magnetic blow-out Blow-out magnets available to switch high DC currents Rated operating current/voltage I <sub>e</sub> /U <sub>e</sub> : 1 A / 220 V; 4 A / 24 V Utilisation category: DC-13
...- UE	Slow action with overlapping contacts
...- H	Slow action with staggered contacts
...-RMS	Available with metal roller

**Ordering code**

(1)(2) 017-(3)Y-(4)

(1)	
T	Slow action
M	Snap action
(2)	
S	Plunger S
2S	Telescopic plunger 2S
K	Offset roller lever K
2K	Rocking offset roller lever 2K
3K	Angle roller lever 3K
8H	Roller lever 8H
7H	Roller lever 7H
10H	Rod lever 10H
H	Roller lever H
4H	Spring rod lever on shaft 4H
2H	Leaf-spring lever 2H
3H	Roller lever 3H
9H	Rod lever 9H
6H	Leaf-spring lever 6H

<b>(3)</b>	
<b>22</b>	2 Normally open contact (NO) / 2 Opener (NC)
<b>13</b>	1 Normally open contact (NO) / 3 Opener (NC)
<b>31</b>	3 Normally open contact (NO) / 1 Opener (NC)
<b>(4)</b>	
<b>UE</b>	Slow action with overlapping contacts
<b>H</b>	Slow action with staggered contacts
<b>C</b>	Magnetic blow-out

## Documents

---

**Operating instructions and Declaration of conformity** (nl) 95 kB, 20.07.2018

Code: mrlk\_posi-allgemein\_nl

**Operating instructions and Declaration of conformity** (ru) 133 kB, 09.07.2018

Code: mrlk\_posi-allgemein\_ru

**Operating instructions and Declaration of conformity** (es) 88 kB, 09.07.2018

Code: mrlk\_posi-allgemein\_es

**Operating instructions and Declaration of conformity** (en) 86 kB, 09.07.2018

Code: mrlk\_posi-allgemein\_en

**Operating instructions and Declaration of conformity** (cn) 138 kB, 09.07.2018

Code: mrlk\_posi-allgemein\_cn

**Operating instructions and Declaration of conformity** (it) 86 kB, 09.07.2018

Code: mrlk\_posi-allgemein\_it

**Operating instructions and Declaration of conformity** (jp) 285 kB, 09.07.2018

Code: mrlk\_posi-allgemein\_jp

**Operating instructions and Declaration of conformity** (pl) 118 kB, 09.07.2018

Code: mrlk\_posi-allgemein\_pl

**Operating instructions and Declaration of conformity** (fr) 85 kB, 09.07.2018

Code: mrlk\_posi-allgemein\_fr

**Operating instructions and Declaration of conformity** (pt) 86 kB, 09.07.2018

Code: mrlk\_posi-allgemein\_pt

**Operating instructions and Declaration of conformity** (de) 88 kB, 09.07.2018

Code: mrlk\_posi-allgemein\_de

**Declaration of conformity** (de) 93 kB, 27.03.2017

Code: konfi\_mrl\_tm015\_de

**Declaration of conformity** (en) 91 kB, 07.11.2017

Code: konfi\_mrl\_tm015\_en

**CCC certification** (en) 4 MB, 27.10.2017

Code: q\_372p02

**CCC certification** (cn) 4 MB, 27.10.2017

Code: q\_372p03

## Images

---

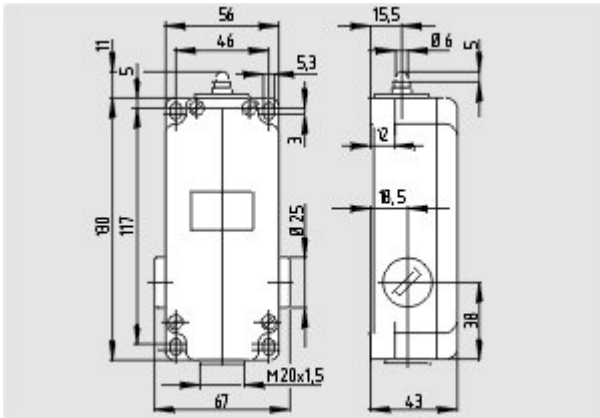

Dimensional drawing (basic component)

---

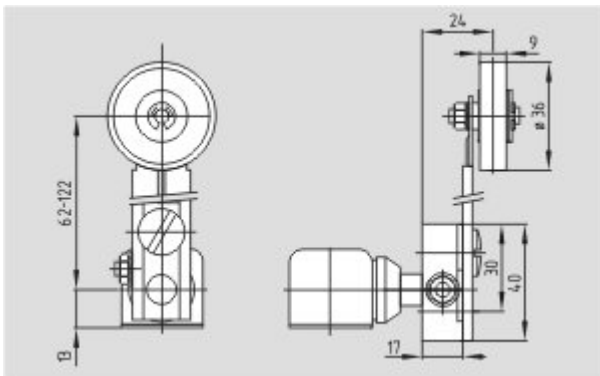

Dimensional drawing (miscellaneous)

---



Operating principle

---