

Datasheet - T3K 017-31Y



Position switch / medium heavy Position switch / Product series 015, 016, 017 - Metal enclosure / 017 / 017 Angle roller lever 3K



- Metal enclosure
- 4 Contacts
- 67 mm x 130 mm x 43 mm (basic component)
- Actuator heads can be repositioned by 4 x 90°
- 3 Cable entry M 20 x 1.5

(Minor differences between the printed image and the original product may exist!)

Ordering details

Product type description	T3K 017-31Y
Article number	101054969
EAN Code	
eCl@ss	27-27-06-01

Approval

Approval



Global Properties

Permanent light	017 Winkelhebel 3K
Standards	EN 60947-5-1
Compliance with the Directives (Y/N) 	Yes
Suitable for safety functions (Y/N)	No
Standard housing (Y/N)	No
Materials	
- Material of the housings	light alloy die-casting, painted
- Roller material	Plastic
- Material of the contacts	Silver
Housing coating	painted

Weight	442
Slide form	Castor

Mechanical data

Design of electrical connection	Screw connection
Cable section	
- Min. Cable section	1.5
- Max. Cable section	2.5
AWG-Number	13
Active principle	mechanical
Mechanical life	5.000.000 operations
notice	All indications about the cable section are including the conductor ferrules.
Design of actuating element	Angle roller lever
Actuating force	13 N
Bounce duration	
Switchover time	
Contact opening	2 x 2.5
Actuating speed with vertical actuating angle to switch axis	
- Min. Actuating speed	1
- Max. Actuating speed	0,5
- Actuating angle from below	45

Ambient conditions

Ambient temperature	
- Min. environmental temperature	-30
- Max. environmental temperature	+90
Protection class	IP65 to IEC/EN 60529

Electrical data

Design of control element	Normally open contact (NO), Opener (NC)
- Change-over contact with double break	
Switching principle	Creep circuit element
- positive break NC contact	
Number of shutters	3
Number of openers	1
Rated insulation voltage U_i	500 V
Thermal test current I_{the}	10 A
Utilisation category	AC-15: 400 V / 4 A
Max. fuse rating	20 A gG D-fuse

Dimensions



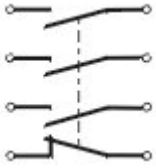

Dimensions of the sensor	
- Width of sensor	67
- Height of sensor	171
- Length of sensor	43
Roller wide	8.5
Roller diameter	20

notice

Diagram



Note Diagram

-  positive break NC contact
-  active
-  no active
-  Normally-open contact
-  Normally-closed contact

Ordering suffix

The applicable ordering suffix is added at the end of the part number of the safety switch.

Order example: T3K 017-31Y- **C**

...- C	Magnetic blow-out Blow-out magnets available to switch high DC currents Rated operating current/voltage I_e/U_e : 1 A / 220 V; 4 A / 24 V Utilisation category: DC-13
...- H	Slow action with staggered contacts
...- UE	Slow action with overlapping contacts
...- RMS	Available with metal roller

Ordering code

(1)(2) 017-(3)Y-(4)

(1)

T	Slow action
M	Snap action
(2)	
S	Plunger S
2S	Telescopic plunger 2S
K	Offset roller lever K
2K	Rocking offset roller lever 2K
3K	Angle roller lever 3K
8H	Roller lever 8H
7H	Roller lever 7H
10H	Rod lever 10H
H	Roller lever H
4H	Spring rod lever on shaft 4H
2H	Leaf-spring lever 2H

3H	Roller lever 3H
9H	Rod lever 9H
6H	Leaf-spring lever 6H
(3)	
22	2 Normally open contact (NO) / 2 Opener (NC)
13	1 Normally open contact (NO) / 3 Opener (NC)
31	3 Normally open contact (NO) / 1 Opener (NC)
(4)	
UE	Slow action with overlapping contacts
H	Slow action with staggered contacts
C	Magnetic blow-out

Documents

Operating instructions and Declaration of conformity (nl) 95 kB, 20.07.2018

Code: mrlk_posi-allgemein_nl

Operating instructions and Declaration of conformity (ru) 133 kB, 09.07.2018

Code: mrlk_posi-allgemein_ru

Operating instructions and Declaration of conformity (es) 88 kB, 09.07.2018

Code: mrlk_posi-allgemein_es

Operating instructions and Declaration of conformity (en) 86 kB, 09.07.2018

Code: mrlk_posi-allgemein_en

Operating instructions and Declaration of conformity (cn) 138 kB, 09.07.2018

Code: mrlk_posi-allgemein_cn

Operating instructions and Declaration of conformity (it) 86 kB, 09.07.2018

Code: mrlk_posi-allgemein_it

Operating instructions and Declaration of conformity (jp) 285 kB, 09.07.2018

Code: mrlk_posi-allgemein_jp

Operating instructions and Declaration of conformity (pl) 118 kB, 09.07.2018

Code: mrlk_posi-allgemein_pl

Operating instructions and Declaration of conformity (fr) 85 kB, 09.07.2018

Code: mrlk_posi-allgemein_fr

Operating instructions and Declaration of conformity (pt) 86 kB, 09.07.2018

Code: mrlk_posi-allgemein_pt

Operating instructions and Declaration of conformity (de) 88 kB, 09.07.2018

Code: mrlk_posi-allgemein_de

Declaration of conformity (de) 93 kB, 27.03.2017

Code: konfi_mrl_tm015_de

Declaration of conformity (en) 91 kB, 07.11.2017

Code: konfi_mrl_tm015_en

CCC certification (en) 4 MB, 27.10.2017

Code: q_372p02

CCC certification (cn) 4 MB, 27.10.2017

Code: q_372p03

EAC certification (ru) 388 kB, 20.01.2016

Code: q_1527p17_ru

Images

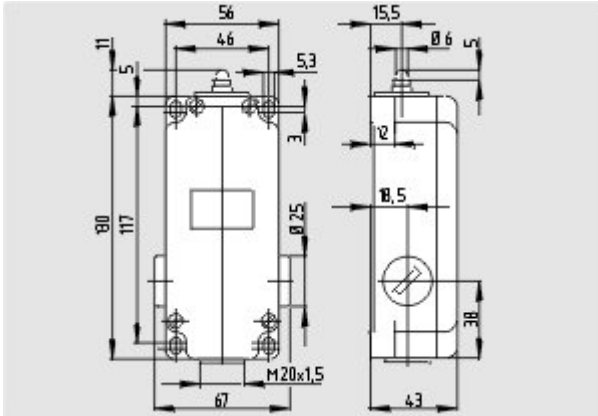

Dimensional drawing (basic component)

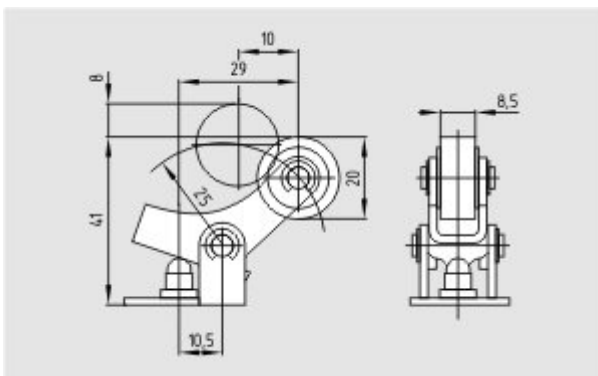

Dimensional drawing (miscellaneous)

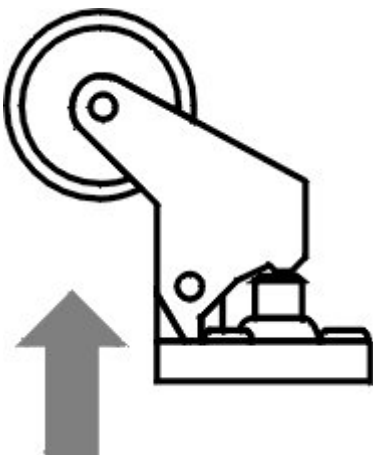

Operating principle
