

- Contactless, robust sensor system
- Infinite resolution, no hysteresis
- Digital interface SSI
- Resolution 12 Bits / natural binary
- Gauge with spring return up to 100 mm
- Protection class IP 66

Construction and operating principle

The displacement transducer operates according to the principle of the differential choke, i.e. an inductive half bridge. It consists of two coils which are encapsulated in a stainless steel cylinder. A mu-metal plunger core causes opposing changes of inductance when it is displaced through the centre of the coils. These changes are converted by the integral electronic circuit into a signal proportional to the displacement. A 12 bits A/D converter supplied a proportional digital signal which can be calibrated before delivery via an integral-controller.

The transducers are completely sealed to ensure positive protection against vibration, shock, humidity, oil and corrosive matter.

Standard measuring strokes: 20 mm, 40 mm, 100 mm, 200 mm

Special calibration

Up on request the measuring stroke can be reduced without affecting neither the resolution nor the case length, e.g. 30 mm measuring stroke (IWE 250/300) will be generated using IWE 250/40.

Electrical data

- Supply voltage range V_S : 21.5 to 32 VDC
(prot'd against reverse polarity)
- Output code: Natural binary
- Data output: SSI-Differential
- Clock input: SSI-Differential to RS 422
- Monoflops rate: 10 to 30 μ s
- Clock frequency: 125 Hz
- Interface profile: SSI 13 Bits
- Linearity: 0.5 % or 0.25 %
- Temperature drift: < 0.01 %/°C
- Stability: < 0.1 % in 24 hours
- Measurement frequency: 100 Hz max.

Note: If not otherwise indicated all data are valid at 20° C ambient temperature, at $V_S = 24$ VDC and 30 min. turn-on time.

Measuring direction

The measuring signal increases when the plunger moves in direction of the connector. Up to request the reverse action can be calibrated before delivery.

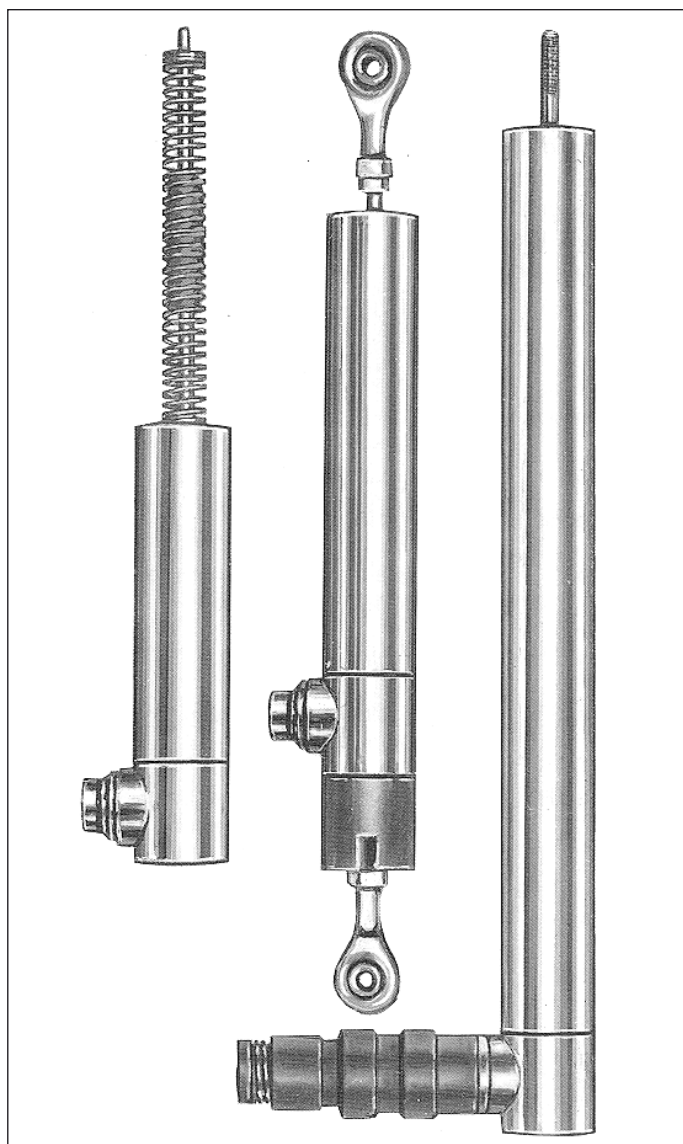

Environmental data

- Operating temperature range: -10° C to +80° C
- Storage temperature range: -30° C to +80° C
- Resistance to shock: 250 g SRS at 20 at 2000 Hz
- Resistance to vibration: 20 g rms (50 g peak) at 20 to 2000 Hz
- Protection class: IP 66

Materials

- External and internal tube : Chrome-nickel steel
- Plunger : Chrome-nickel steel
- Core : Mu-metal
- Connector case : Brass, nickel-plated
- Connector contacts : Gold-plated
- Spring and gauge head : Stainless steel ("T")

SSI (Synchron Serialles Interface)

The absolute information derived by the transducer is converted into serial information and the transmitted to a receiving electronic circuit in synchronism with a clock. Important advantages are: Low number of data lines and high reliability.

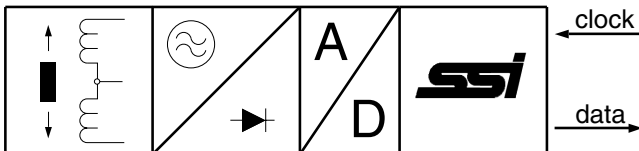

Input and output circuits

Clock (on)

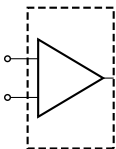

Data (off)

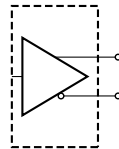

Interface profile SSI - 13 Bits

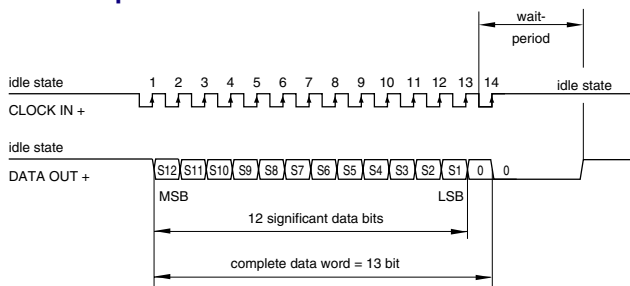

Lengths and masses (refer to drawings page 3)

Type	L1 * mm	L2 mm	without plunger g	plunger only g
IW 250/20	40	110	210	15
IW 250/40	50	140	240	19
IW 250/100	80	250	380	31
IW 250/200	130	500	720	56
Ball joint, front			22 g	
Ball jint rear			55 g	

* L1 = Plunger in central position: 2048 positions.

Electrical connections at plug

(View at connecting face of counter plug)

Pin	Function	PIN	Function
A	TAKT IN -	G	n.c.
B	TAKT IN +	H	n.c.
C	DATA OUT +	J	n.c.
D	DATA OUT -	K	n.c.
E	n.c.	L	+ V _S = 24 VDC
F	n.c.	M	- V _S = 0 Volt

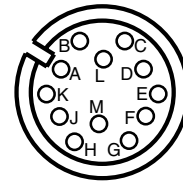

Order code format

IWE 250 / 40 - 0,5 - KFN - KHN - E01*

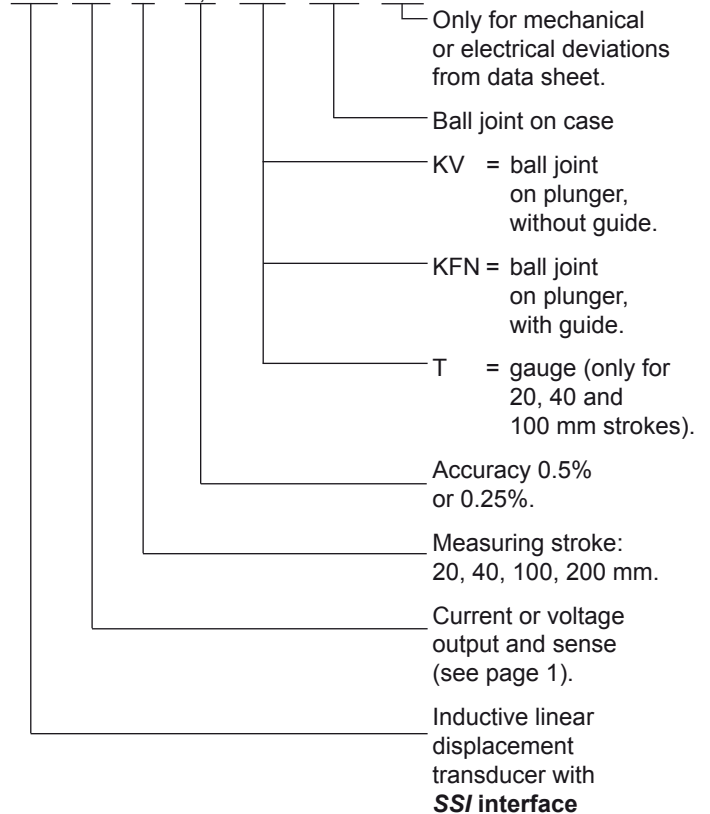

* The applicable A-No. is allocated after the definition of the deviation when ordering. No A-No. is given for standard versions as specified in the data sheet.

Special versions with cable exit will receive "Kx" in addition to above ordering code (X for length of cable).

Accessories (must be ordered separately)

SR: Stainless tube to protect the plunger against lateral pressure (ref. to data sheet 11537).

MB 25 : Metal mounting block.

STK12G30: Counter plug with metal housing straight.

Dimensions in mm

Standard version (without rod guide)

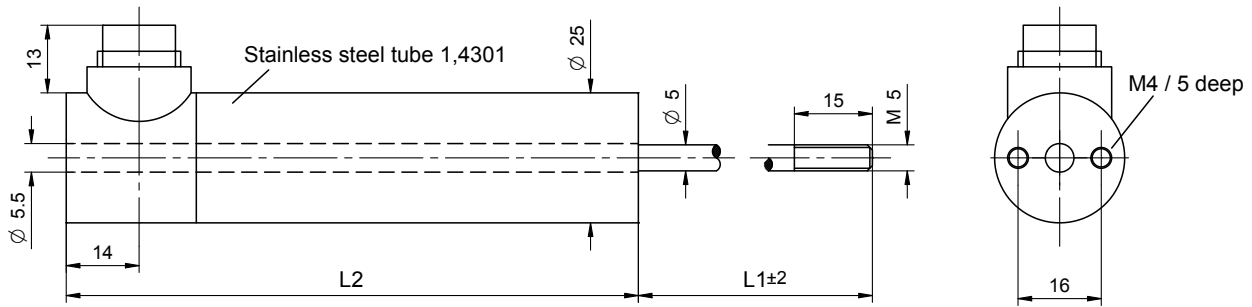

Version with ball joint on plunger (KV) (without rod guide)

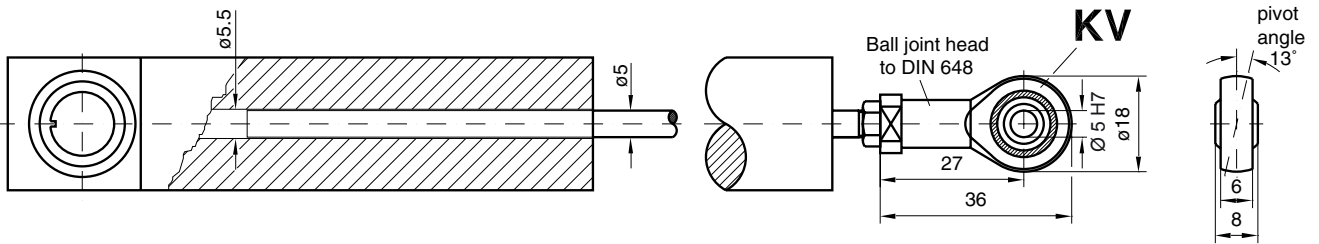

Version with ball joints on plunger (KFN) and on end of case (KFH) (with rod guide, captivated)

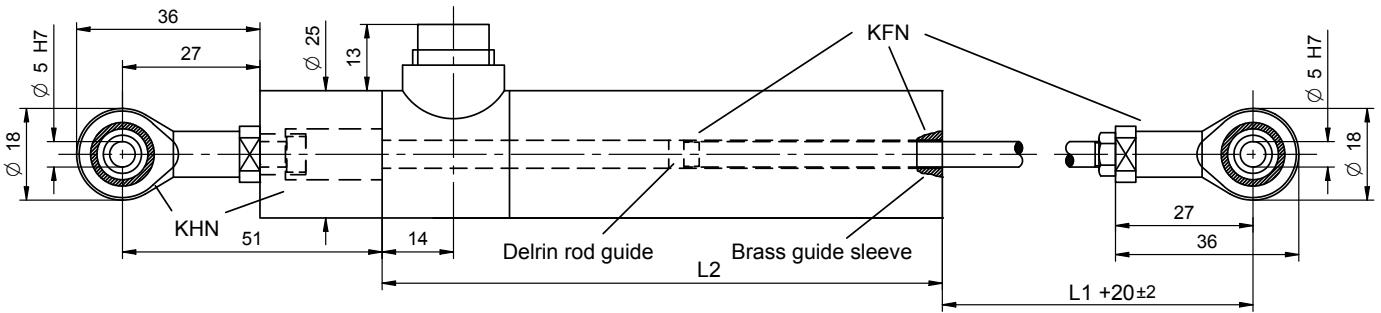

Gauge version (T) with return spring (only up to 100 mm stroke)

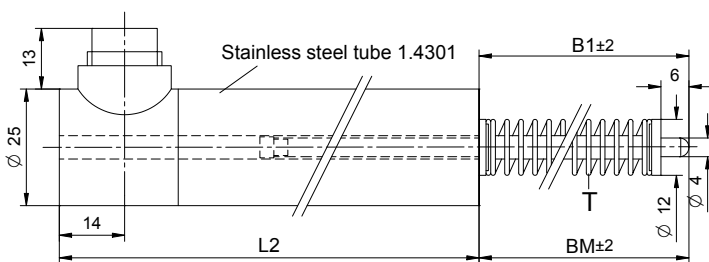

Measuring stroke mm	BM mm	B1 mm	FM N	FC N/m
20	70	85	~ 4	0.14
40	70	98	~ 4	0.07
100	140	198	~ 4	0.03

BM = Plunger in central position
 B1 = Plunger full out
 FM = Spring prestress
 Fc = Spring rate

MB 25 Mounting block, brass Nickel plated (to be ordered separately)

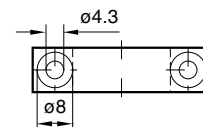
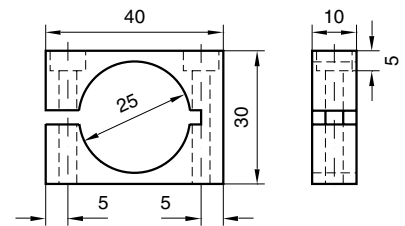

2 hexagon socket screws M4/35 mm long are supplied with each item.

Mass : 60 g

Mating Plugs

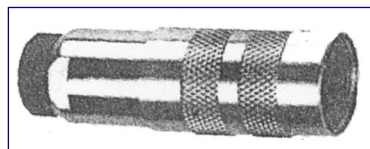

STK12G30:
 Counter plug with metal housing straight.