

Inductive Sensor Head for Extreme Temperature Ranges

INRT004

Part Number



- Long service life of up to 100 000 hours
- Quickly interchangeable sensor head

The sensors consist of a sensor head and an analysis module, and are laid out for use in very hot work environments. Together with unparalleled service life in hot surroundings, large switching distances assure maximum system availability. Easily interchangeable sensor heads with numerous standard cable lengths are additionally available as separate replacement parts. Switching distance can be quickly adjusted via a potentiometer within a temperature range of -60 to 450° C.

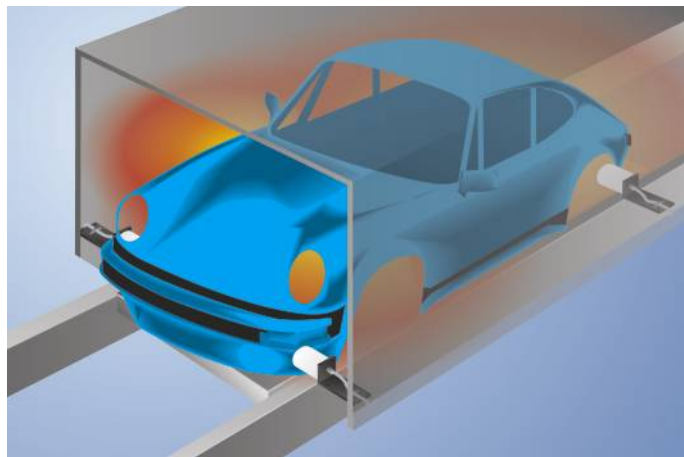

Technical Data

Inductive Data

Switching Distance	25 mm
Correction Factors Stainless Steel V2A/CuZn/Al	1,27/1,29/1,33
Mounting	non-flush
Mounting A/B/C/D in mm	95/200/40/85

Electrical Data

Sensor head temperature range	-60...450 °C
Protection Class	III
Service Life	100000 h

Mechanical Data

Sensor head material	Ceramic
Degree of protection, sensor head	IP60
Connection	M12 × 1; 4-pin
Cable Length (L)	5 m
PWIS-free	yes

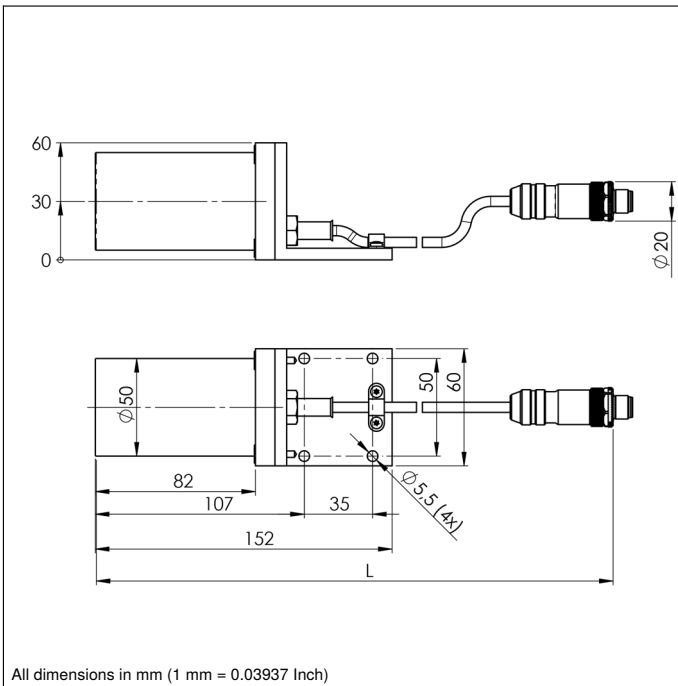

Mounting

