

Protection Column with Protective Screen

SZ000EG170NN01

Part Number



- Floor or wall mounting possible
- Mechanical protection against damages
- Quick and easy alignment through innovative mounting

The wenglor protection column offers optimal protection for safety light curtains and multi-beam safety light arrays in rough surroundings. When combined with the floor mounting, this enables free-standing mounting. The wall mounting is suitable for stable horizontal mounting at standard profiles. The integrated water level enables an intuitive adjustment. A quick and precise axial and vertical alignment can be made with a few quick hand grips.

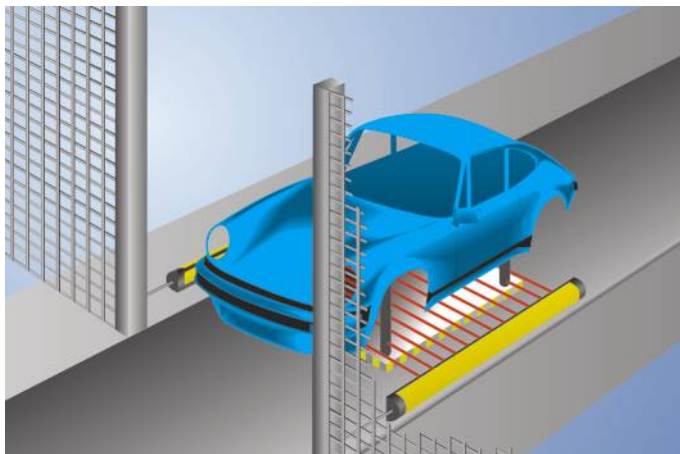

Technical Data

Mechanical Data

Housing Material	Aluminum
Disk Material	Polycarbonate
Cable subway	bottom/top
Installation Space (EBR)	1703 mm

Suitable Mounting Technology No. **710** **770** **780**

Mounting Bracket, Floor or Wall Mounting are required for mounting (not included in delivery)

Complementary Products

Floor Mounting ZMBSZ0001

Mounting Bracket BEF-SET-36

Mounting Bracket ZEMX002

Wall Mounting ZMBSZ0002

