

# Connection Box for M8 × 1; 4-pin; 8 Ports

## ZAA07R502

Part Number



### Technical Data

Electrical Data	
Supply Voltage	18...30,2 V
Mechanical Data	
Connection 1	Socket, 8 ports
Connection mode 1	M8 × 1, 4-pin
Torque	M8: 0,4 Nm +0,1 Nm
Cable Length	5 m
Diameter Cable	9,6 mm
Wire cross-section	0,34 / 0,75 mm <sup>2</sup>
Display	LED
Degree of Protection	IP67
Temperature Range	-20...70 °C
Housing Material	Plastic
Material Cable Jacket	PUR
Material Wire Isolation	PVC
Halogen-free	yes
Drag Chain Suitable	yes
Bending radius (fixed installation)	12 × d
Bending radius (used in motion)	12 × d
Travel speed (with 5 m horizontal travel distance)	2 m/s
Acceleration	5 m/s <sup>2</sup>
Bending cycles	> 2000000
Packaging unit	1 Piece

Suitable Connection Technology No.

**7s**

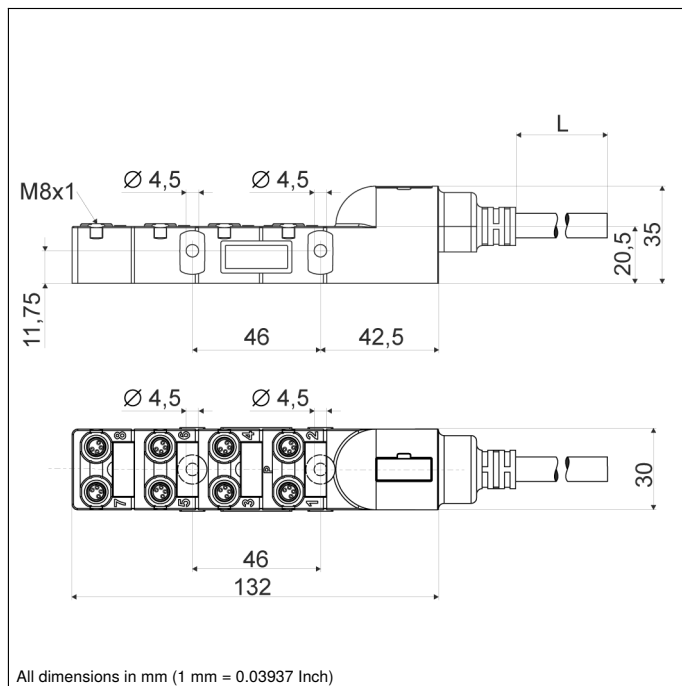

### ● High protection class IP67

